



by **ENOVATION** CONTROLS



# PowerView<sup>®</sup> Model PV1100

## *Installation Manual*

In order to consistently bring you the highest quality, full-featured products, we reserve the right to change our specifications and designs at any time. The latest version of this manual can be found at [enovationcontrols.com](http://enovationcontrols.com).

**Warranty** - A limited warranty on materials and workmanship is given with this Murphy product. A copy of the warranty may be viewed or printed by going to [www.enovationcontrols.com/warranty](http://www.enovationcontrols.com/warranty)



Please read the following information before installing.

**BEFORE BEGINNING INSTALLATION OF THIS MURPHY PRODUCT:**

Read and follow all installation instructions.

Please contact Enovation Controls immediately if you have any questions.

# Table of Contents

<b>Hardware Installation .....</b>	<b>1</b>
Inspecting Package Contents .....	1
Dash-Mounted Installation .....	1
Mounting Bracket .....	3
<b>Wiring Information .....</b>	<b>5</b>
Pin Out Specifications .....	5
<b>Configuration Information .....</b>	<b>8</b>
Wiring Schematics – Black Connector (Valid for all non-connected wiring).....	9
Wiring Schematics – Gray Connector (Valid for all non-connected wiring).....	10
<b>Specifications.....</b>	<b>11</b>
<b>Dimensions.....</b>	<b>13</b>

THIS PAGE INTENTIONALLY LEFT BLANK

## Hardware Installation

The following instructions will guide you through installing the PowerView display.

### Inspecting Package Contents

Before attempting to install the product, it is recommended that you ensure all parts are accounted for and inspect each item for damage (which sometimes occurs during shipping). The items included in the box are:

- PV1100 unit
- Installation manual web reference insert

### Dash-Mounted Installation

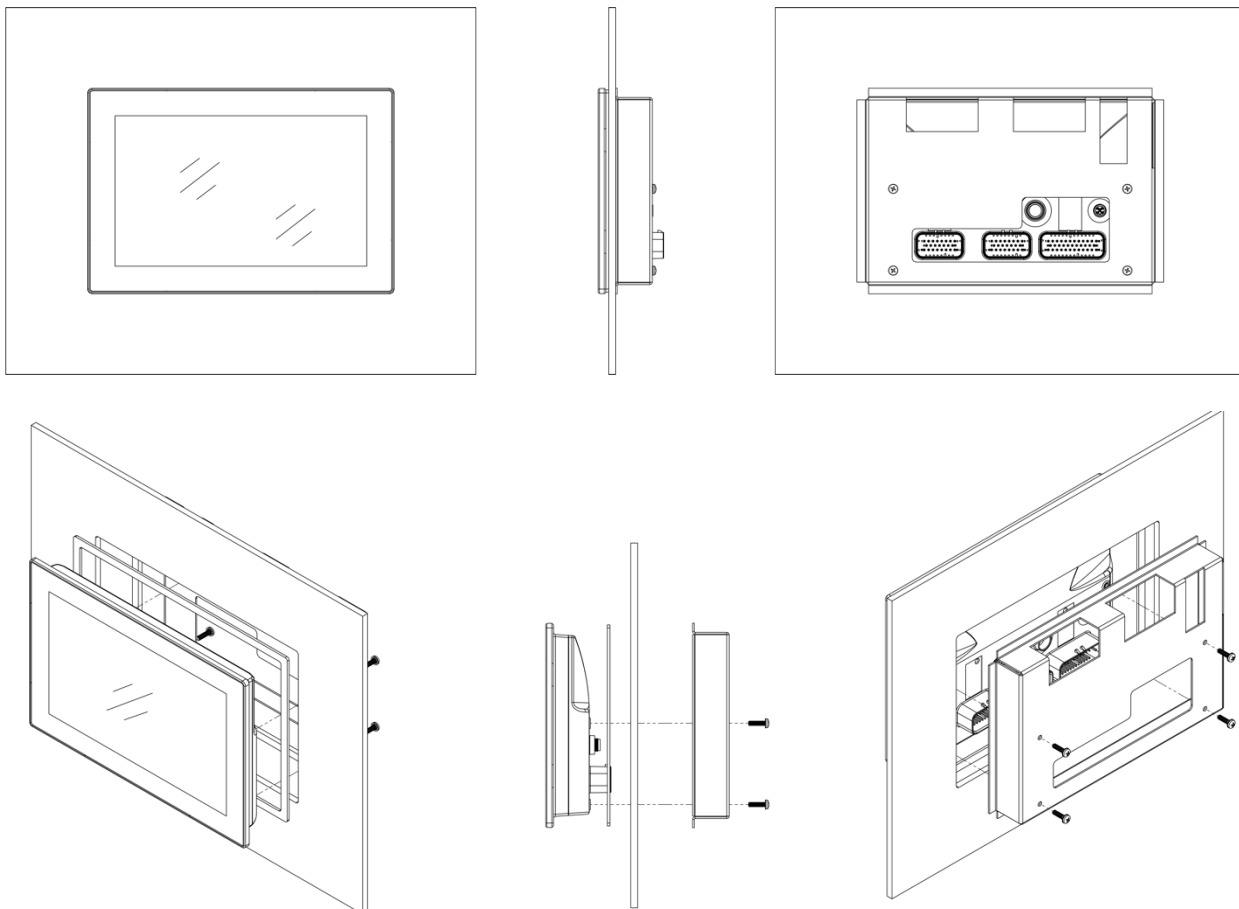

Installation kit (sold separately) – P/N 78-00-1277 includes:

- Bracket
- Panel Seal
- (4) 8-32 machine screws

Tools needed.

- Drill with 7/32 in. size bit
- Jigsaw

## Preparing the Dash

Determine the location of the PV1100 in the dash. Cut a hole in the dash to these dimensions:  
(For actual cutout template, see [support.enovationcontrols.com](http://support.enovationcontrols.com), then search for PV1100)

- (recessed mounting): 10.45" x 6.79" (265.61mm x 172.61mm)

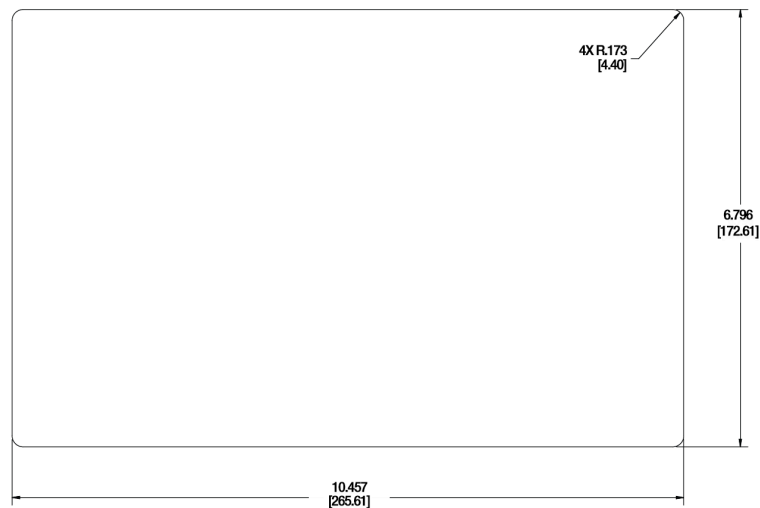

- (surface mounting): 7.28" x 2.56" (185mm x 65mm)

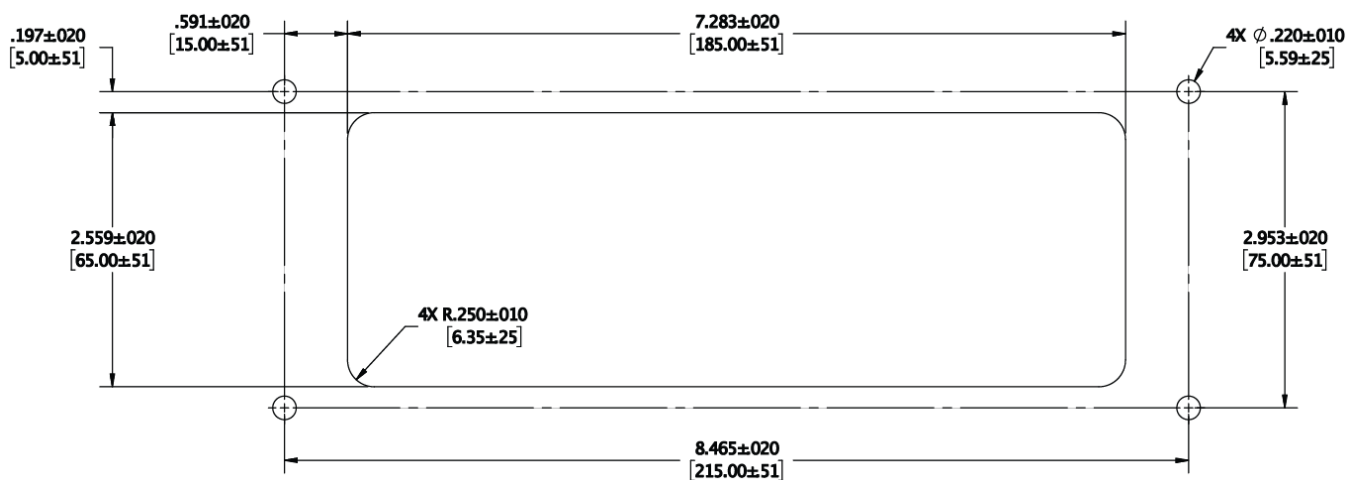

## Mounting the Unit

1. Place the back side of the display through the opening in the dash.
2. Use the four included screws from the mounting kit (78-00-1277) to attach the unit to the bracket and torque to 10 inch-pounds.

## Mounting Bracket

---

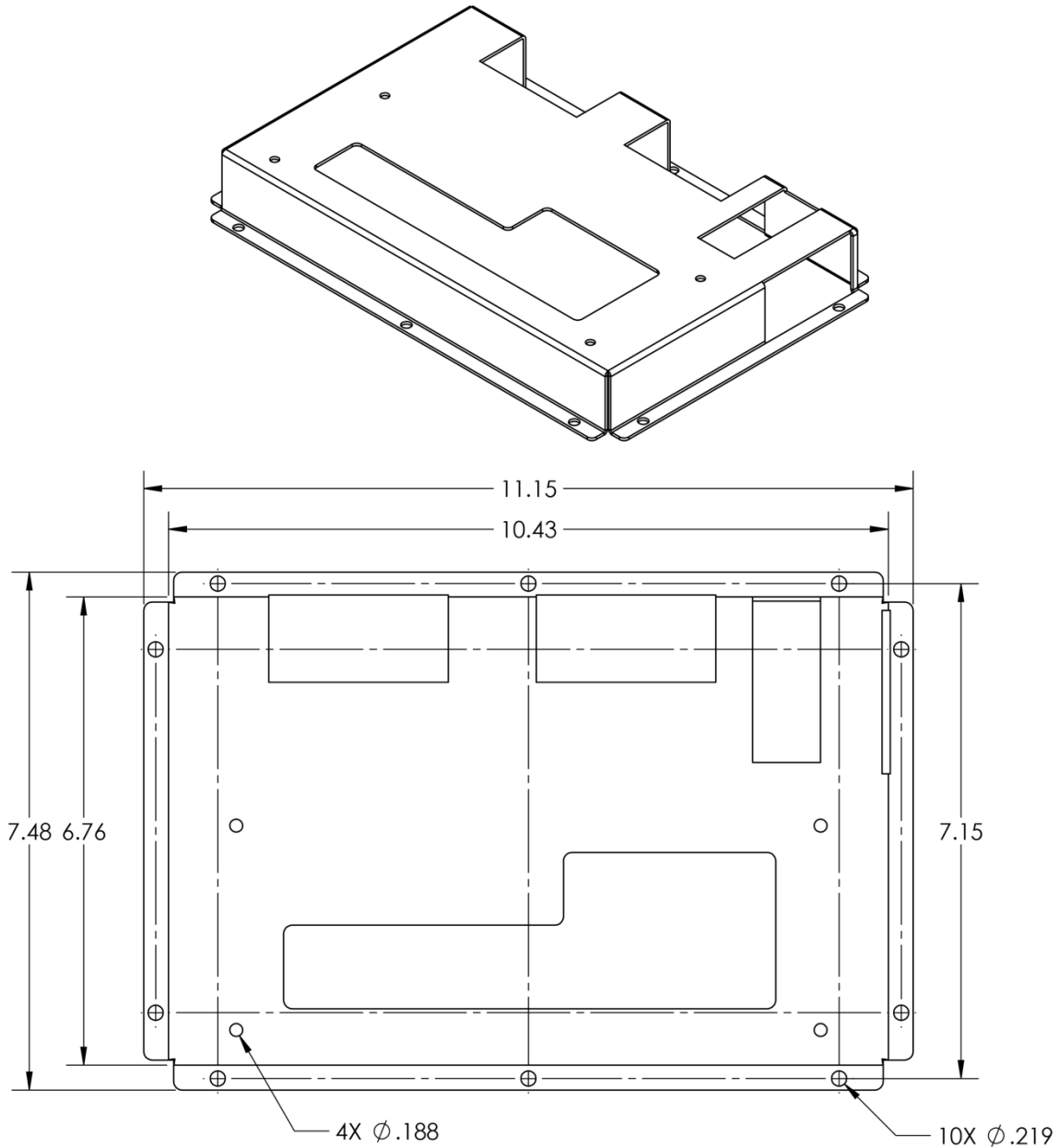

## How to Order

The following PV1100 displays and accessories are available through Enovation Controls:

<b>Part Number</b>	<b>Description</b>	<b>Order Details</b>
<b>78700636</b>	PV1100, Touch, Non-connected, Landscape	<b>Display</b>
<b>78700654</b>	PV1100, Touch, Non-connected, Portrait	<b>Display</b>
<b>78090098</b>	Programming Kit, PV780/PV1100	<b>Accessories</b>
<b>78001277</b>	Kit, Mounting Bracket, PV1100	
<b>78001055</b>	Harness, Gray Connector, USB	
<b>78001056</b>	Harness, Gray Connector, Flying Leads	
<b>78001057</b>	Harness, Black Connector, Flying Leads	
<b>78001017</b>	Harness, Black Connector, Development	
<b>78001018</b>	Harness, Gray Connector, Development	
<b>78090069</b>	Harness, PV750/PV1100 Conversion, Power/CAN	



## Wiring Information

### Pin Out Specifications

Black Connector	
1	Digital Input 1
2	Analog Input 3
3	Analog Input 2
4	Analog Input 1
5	CAN1 Low
6	CAN1 High
7	Battery
8	Ground
9	Analog Input 3 Ground
10	Analog Input 2 Ground
11	Analog Input 1 Ground
12	Digital Input 3
13	Digital Input 2
14	Frequency Output 1
15	Ignition Input
16	No Connect
17	No Connect
18	CAN2 Low
19	CAN2 High
20	Digital Input 4
21	Digital Input 5
22	Digital Output
23	Frequency Output 2

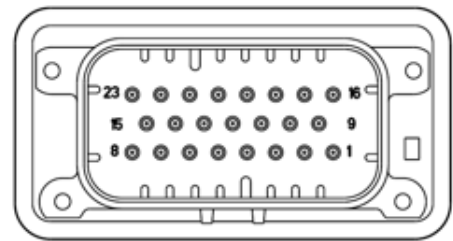

**AMP 770680-1**

Gray Connector	
1	Video Input 1 NTSC/PAL
2	Video Input 2 NTSC/PAL
3	Video Input 3 NTSC/PAL
4	RS-485 High
5	RS-485 Low
6	LINE_OUT_1_R Negative Audio Out - Right
7	LINE_OUT_1_R Positive Audio Out - Right
8	LINE_OUT_1_L Negative Audio Out - Left
9	Video Input 1 Ground
10	Video Input 2 Ground
11	Video Input 3 Ground
12	No Connect
13	Frequency Input
14	Frequency Return
15	LINE_OUT_1_L Positive Audio Out - Left
16	USB D- White (Data -)
17	USB D+ Green (Data +)
18	USB 5V Red (+5V)
19	USB Ground Black
20	USB Shield
21	No Connect
22	No Connect
23	No Connect

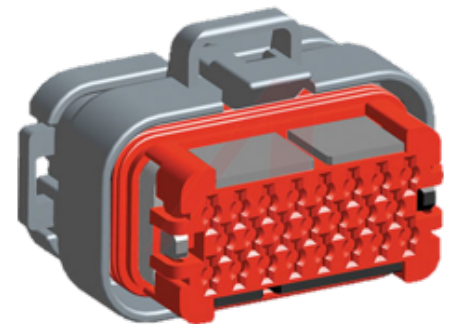
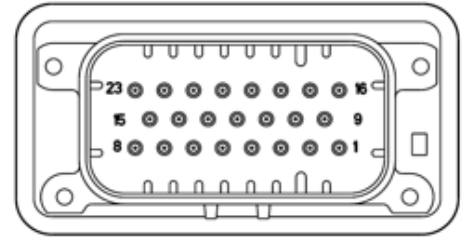

**AMP 770680-4**

35 Pin Black Connector	
1, 2, 3, 4	No Connect
5	LINE_IN_1_L Audio In
6	LINE_IN_1_L Return Audio In
7	LINE_IN_1_R Audio In
8	LINE_IN_1_R Return Audio IN
9	LINE_IN_2_L Audio In
10	LINE_IN_2_L Return Audio In
11	LINE_IN_2_R Audio In
12	LINE_IN_2_R Return Audio In
13, 14, 15	No Connect
16	LINE_OUT_5_L Positive Audio Out - Left
17	LINE_OUT_5_L Negative Audio Out - Left
18	LINE_OUT_4_L Positive Audio Out - Left
19	LINE_OUT_4_L Negative Audio Out - Left
20	LINE_OUT_3_L Positive Audio Out - Left
21	LINE_OUT_3_L Negative Audio Out - Left
22	LINE_OUT_2_L Positive Audio Out - Left
23	LINE_OUT_2_L Negative Audio Out - Left
24	AMP_TURN_ON 3 Accessory Output 2
25	AMP_TURN_ON 2 Accessory Output 1
26	AMP_TURN_ON 1 Amp Control
27	No Connect
28	LINE_OUT_5_R Positive Audio Out – Right
29	LINE_OUT_5_R Negative Audio Out - Right
30	LINE_OUT_4_R Positive Audio Out - Right
31	LINE_OUT_4_R Negative Audio Out - Right
32	LINE_OUT_3_R Positive Audio Out - Right
33	LINE_OUT_3_R Negative Audio Out - Right
34	LINE_OUT_2_R Positive Audio Out - Right
35	LINE_OUT_2_R Negative Audio Out - Right

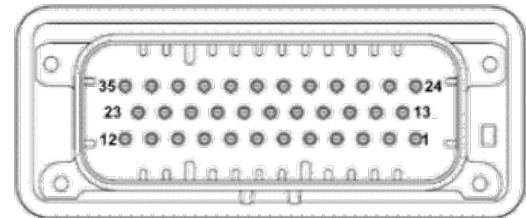

**AMP 776164-1**

**NOTE:** The 35-pin connector pins are only active for the connected stereo option.

Ethernet (M12) Connector	
1	Ethernet TX+
2	Ethernet RX+
3	Ethernet TX-
4	Ethernet RX-
5	Ethernet Ground

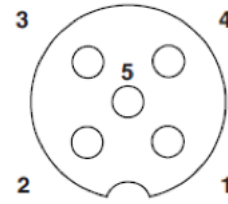

M-12, 5-pos, A-coded  
Plastic Knurl Connector Only

**NOTE:** Ethernet connectivity is optional. Available on connected and connected stereo options.

## Configuration Information

Follow these steps to download a custom configuration to the PV1100 display:

Step	Action
1	Turn off the display.
2	Insert the USB drive that contains the new configuration file into the display's attached USB pigtail.
3	Place a magnet onto the spot shown here on the upper middle back of the display: 
4	Power the display back on, continually holding the magnet in place.
5	Remove the magnet when the display shows the utility for loading new software.
6	Touch the arrow keys on the screen to select the configuration file from the USB to be loaded into the display. Start the configuration load by pressing the right arrow/green key on the screen twice. When complete, the unit will reboot into the loaded application.

# Wiring Schematics – Black Connector (Valid for all non-connected wiring)



**WARNING:** Failure to install the unit per the specified wiring diagrams may cause damage to the unit. **DO NOT** connect power to the video ground. Warranty is void for damage caused by incorrect wiring.

## J1 (BLACK CONNECTOR)

### Analog Inputs

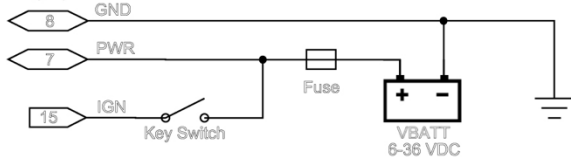

### NOTES:

- Mating connector AMPSEAL 770680-1 plug with 770854-3 sockets
- Use 20 to 16 AWG (0.5 to 1.4 mm<sup>2</sup>)
- Wire diameter of 1.7 to 2.7 mm.
- Install seal plug 770678-1 in perforated connector wire cavities
- An ISO8820 certified automotive fuse rated for no more than 5A shall be used to power the unit. ⚠

### Communications (CAN 2.0A/B)

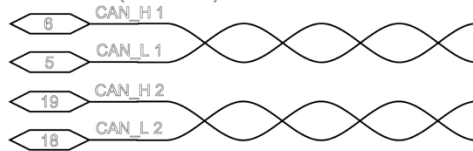

### Wires per J1939-11 (STP) or J1939-15 (UTP)

- J1939-11: Keep stub <1m length; up to 30 nodes; 40m max length
- J1939-15: Keep stub <3m length; up to 10 nodes; 40m max length
- Locate display node >0.1m from nearest node
- Space nodes unequally
- Keep CANbus trunk as linear as possible
- Type I - Use external 120 ohm terminator
- Type II - Enable internal terminator

### Analog Inputs

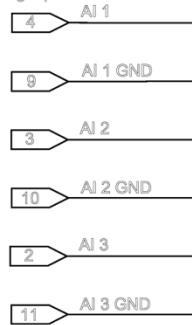

### Ungrounded Senders - Connect signal and return

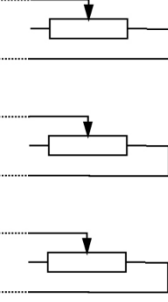

### Grounded Senders - Connect signal only

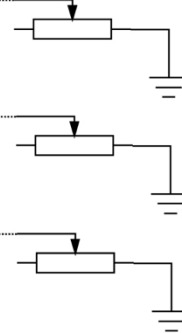

### 0-5 VDC Sensors

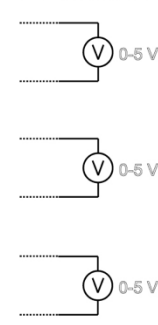

### 4-20 mA Sensors

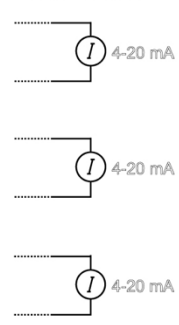

### Digital Inputs

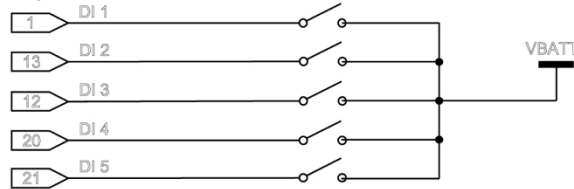

### Digital Output

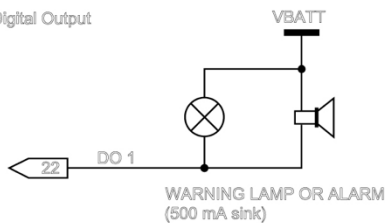

### Frequency Output

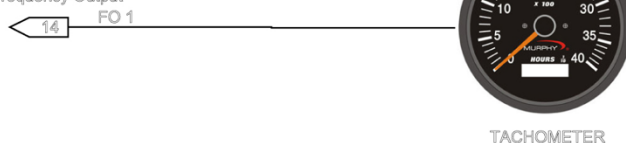

## Wiring Schematics – Gray Connector (Valid for all non-connected wiring)



**WARNING:** Failure to install the unit per the specified wiring diagrams may cause damage to the unit. **DO NOT** connect power to the video ground. Warranty is void for damage caused by incorrect wiring.

### J2 (GRAY CONNECTOR)

#### NOTES:

- Mating connector AMPSEAL 770680-4 plug with 770654-3 sockets
- Use 20 to 16 AWG (0.5 to 1.4 mm<sup>2</sup>)
- Wire diameter of 1.7 to 2.7 mm.
- Install seal plug 770678-1 in perforated connector wire cavities

#### USB (Programming and Data Logging)

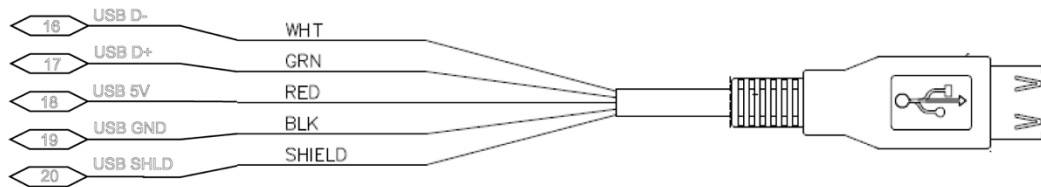

#### Video Inputs



#### Frequency Input (Engine or Shaft Speed from mag pick-up)

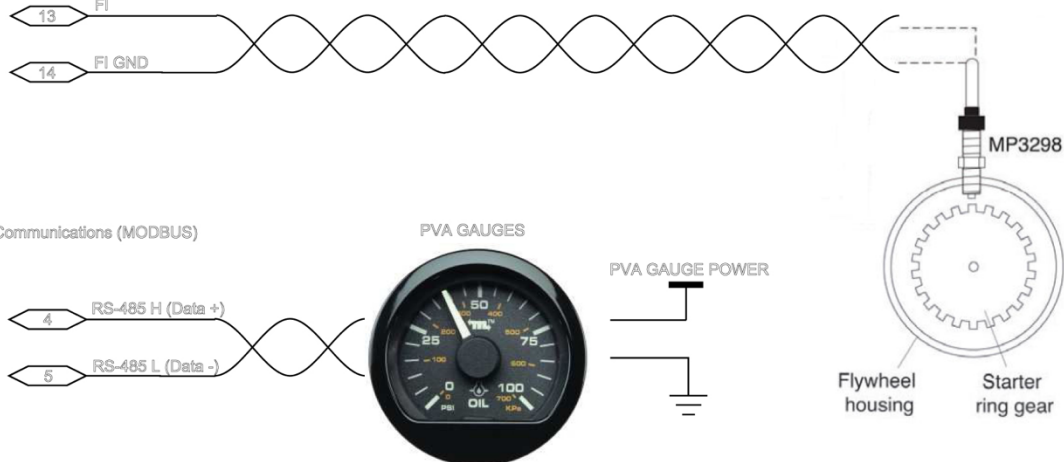

#### Communications (MODBUS)



## Specifications

Computing	
<b>Main Processor:</b>	Renesas® R-Car M2 with Arm® Cortex-A15 dual core processor @ 1.5 GHz (32-bit)
<b>Operating System:</b>	QNX® Real-time Operating System
<b>Storage:</b>	8 GB Flash memory
<b>Ram:</b>	512 MB DDR3-SDRAM
<b>Graphics:</b>	Renesas graphics processor
Display	
<b>Type:</b>	10.6" [231.36 mm (H) X 138.82 mm (W)] viewable area, LVDS TFTS LCD with LED backlight, 24-bit color
<b>Resolution:</b>	1280 x 768
<b>Contrast Ratio:</b>	1000:1 (typical)
<b>Brightness:</b>	1000 cd/m <sup>2</sup>
<b>Surface:</b>	Anti-glare
<b>Touch Panel:</b>	Projected capacitive (PCAP) with glove touch
Hardware	
<b>Real-time Clock:</b>	Available with battery backup
<b>Connectors:</b>	(2) Ampseal 23 pin (Main) (1) Ampseal 35 pin (1) M12, 5-pin (Ethernet) (1) USB pigtail (1) Radio antenna jack (optional)
<b>Video Inputs:</b>	(3) NTSC/PAL
Communication	
<b>CAN:</b>	(2) CAN 2.0B according to ISO 11898-2, J1939 and proprietary messaging
<b>Serial:</b>	(1) RS-485 serial (Modbus: Master/Slave)
<b>USB:</b>	(1) USB 2.0 full speed host
<b>Ethernet:</b>	(1) Ethernet 10/100 Base-T (optional)
<b>Wi-Fi:</b>	802.11 b/g radio (optional)
<b>Bluetooth:</b>	Fully integrated Bluetooth 2.1, Class 1 (optional)

<b>Electrical</b>	
<b>Operating Volts:</b>	6-36 VDC, reverse polarity protected
<b>Outputs:</b>	(1) 500 mA Switched Low-side (1) Frequency Output (2Hz – 3KHz)
<b>Inputs:</b>	(3) Analog 0-5 VDC, 4-20mA, Resistive, 10-bit resolution (5) Discrete digital, active high (1) Frequency input
<b>Environmental</b>	
<b>Operating Temperature:</b>	-40°C to +70°C (-40°F to +158°F)
<b>Storage Temperature:</b>	-40°C to +85°C (-40°F to +185°F)
<b>Protection:</b>	IP66 and IP67, front and back, for outdoor use
<b>Vibration:</b>	3.9 Grms (10 – 350Hz), 3 axes (ISO15003)
<b>Shock:</b>	±50G in 3 axes
<b>EMC/EMI:</b>	SAE J1113, ISO 13766, CE per 2014/30/EU



# Dimensions

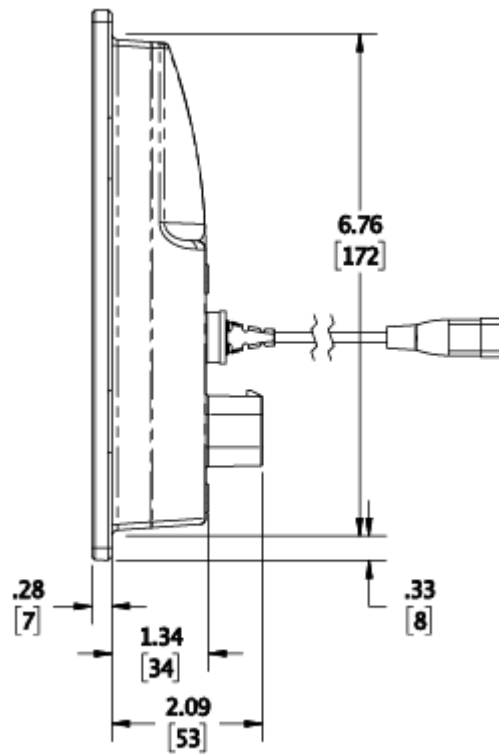
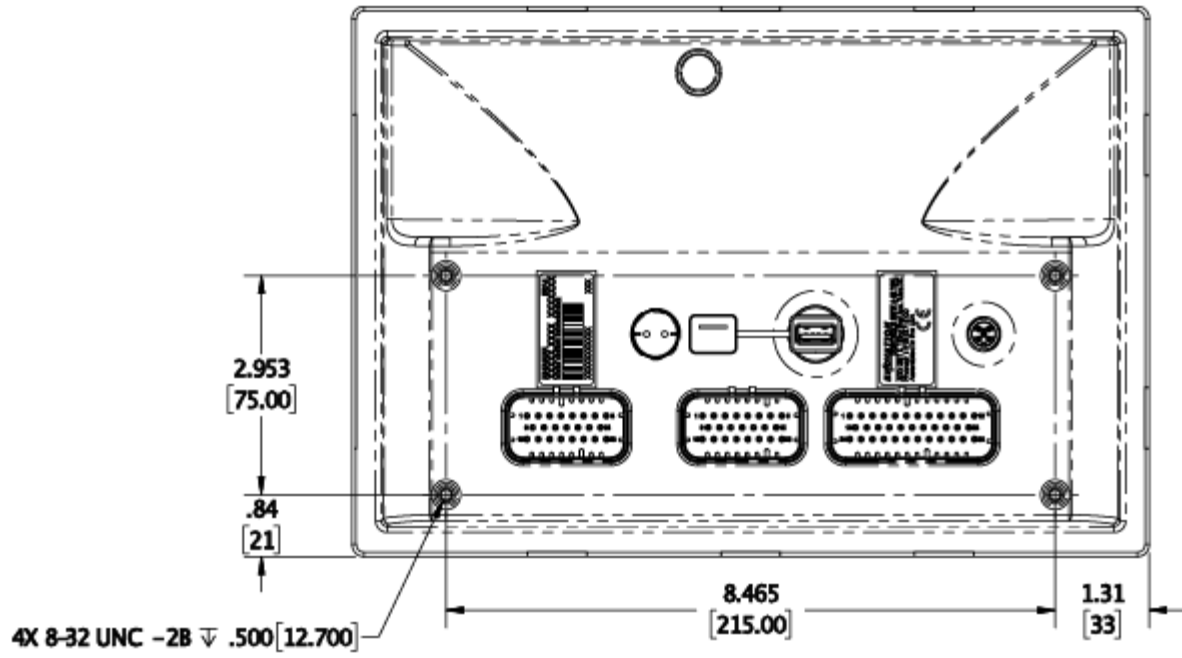

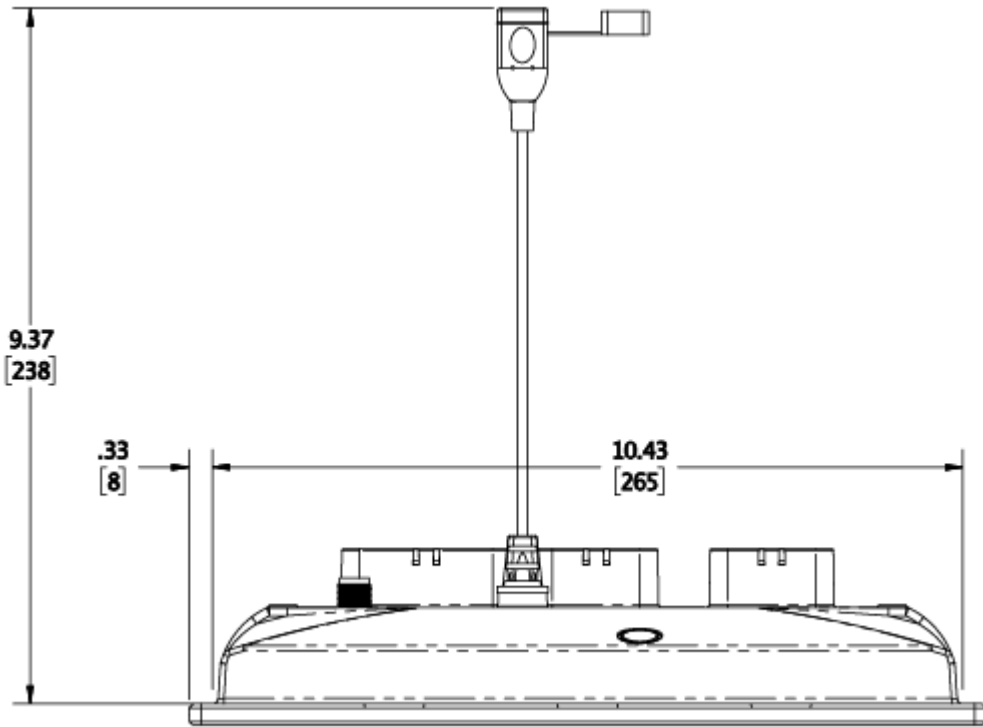

Measurements shown in inches [mm]

*In order to consistently bring you the highest quality, full-featured products, we reserve the right to change our specifications and designs at any time. MURPHY products and the Murphy logo are registered and/or common law trademarks of Enovation Controls, LLC. This document, including textual matter and illustrations, is copyright protected by Enovation Controls, LLC, with all rights reserved. (c) 2018 Enovation Controls, LLC. A copy of the warranty may be viewed or printed by going to [www.enovationcontrols.com/warranty](http://www.enovationcontrols.com/warranty)*

**ENOVATION CONTROLS CORPORATE HEADQUARTERS**

5311 S 122ND EAST AVENUE  
TULSA, OK 74146

**ENOVATION CONTROLS LTD. – UNITED KINGDOM**

CHURCH ROAD LAVERSTOCK  
SALISBURY SP1 1QZ UK

**SUN MURPHY INTERNATIONAL TRADING (SHANGHAI) CO., LTD**

B15 ROOM, 6# BUILDING, 351 SIZHUAN ROAD  
SONGJIANG DISTRICT, SHANGHAI 201601, CHINA

**ENOVATION CONTROLS INDIA PVT. LTD.**

301, 3RD FLOOR, KRSNA CHAMBERS,  
11 GALAXY GARDENS, NORTH MAIN ROAD,  
KOREGAON PARK, PUNE 411001,  
MAHARASHTRA, INDIA

**U.S. SALES & SUPPORT**

PHONE: 918 317 4100  
EMAIL: [SALES@ENOVATIONCONTROLS.COM](mailto:SALES@ENOVATIONCONTROLS.COM)  
[WWW.ENOVATIONCONTROLS.COM](http://WWW.ENOVATIONCONTROLS.COM)

**MURPHY INDUSTRIAL PANEL DIVISION**

PHONE: 918 317 4100  
EMAIL: [IPDSALES@ENOVATIONCONTROLS.COM](mailto:IPDSALES@ENOVATIONCONTROLS.COM)

**INTERNATIONAL SALES & SUPPORT**

**EUROPE, MIDDLE EAST, AFRICA**

PHONE: +44 1722 410055  
EMAIL: [SALES@ENOVATIONCONTROLS.EU](mailto:SALES@ENOVATIONCONTROLS.EU)

**CHINA**

PHONE: +86 21 6237 5885  
EMAIL: [APSALES@ENOVATIONCONTROLS.COM](mailto:APSALES@ENOVATIONCONTROLS.COM)

**INDIA**

PHONE: +91 91581 37633  
EMAIL: [INDIASALES@ENOVATIONCONTROLS.COM](mailto:INDIASALES@ENOVATIONCONTROLS.COM)



FM 28221 (Tulsa, OK - USA)  
FM 29422 (UK)