

MURPHY®

by **ENOVATION** CONTROLS



PowerView®

Model PV25

Installation/Operations Manual

00-02-0839
2018-07-10
Section 78

In order to consistently bring you the highest quality, full-featured products, we reserve the right to change our specifications and designs at any time. The latest version of this manual can be found at enovationcontrols.com

Warranty - A limited warranty on materials and workmanship is given with this Murphy product. A copy of the warranty may be viewed or printed by going to www.enovationcontrols.com/warranty



Please read the following information before installing.

BEFORE BEGINNING INSTALLATION OF THIS MURPHY PRODUCT:

- Read and follow all installation instructions.
- Please contact Enovation Controls immediately if you have any questions.

Table of Contents

Introduction	1
Basic Functions	1
Main Menu	2
Parameter Menu	6
Faults, Warnings and Indicators	7
Visual Indication	7
Indicators for Active Fault Codes	7
Warning or Shutdown Screens	7
Tier 4 and EU Emissions Standard – Stage IV	8
Mounting and Installation	9
Product Dimensions.....	9
Connection Detail	9
Typical Wiring Diagram.....	9
Specifications	11

THIS PAGE INTENTIONALLY LEFT BLANK

Introduction

The PV25 diagnostic device is an economical, compact package with advanced features. This J1939-compliant device provides parameter data, displays active and stored fault messages, provides Tier4/Euro Stage IIIB features, and tracks machine and engine hours.

The PV25 is equipped with two buttons to quickly access a convenient menu, a graphic display, and two LEDs to indicate Active-fault Alarm or Shutdown status in a sealed enclosure that matches the PowerView line of displays.

Basic Functions

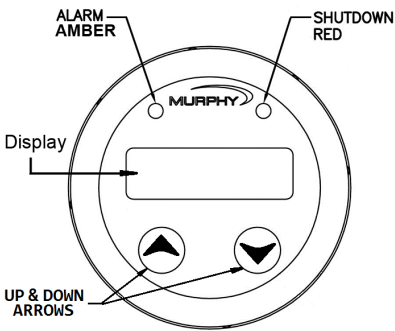

Access all menus and functions of the PV25 by using the **UP** and **DOWN** arrows on the front of the gauge.

When power is first applied to the PV25, **Parameter** readings begin to display.

Wait to Start - PV25 supports 'Wait to Start' - if the ECU broadcasts a wait to start message, the screen shows 'Wait to Start' and both LEDs light. Once the ECU discontinues the message, the signal becomes inactive, and the message is replaced with parameter readings.

DM13 - PV25 supports DM13. For more information, see page 7.

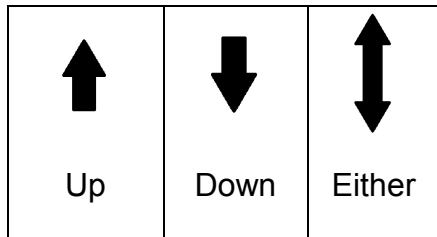

Arrows in the Display field (beside the text information) indicate available movement options – up, down, or either way.

Main Menu

This section describes the items listed in the **Main Menu**. All interface with the PV25 is through the **Up/Down Arrows**. When power is applied to the unit, the Murphy logo displays first, and then the Parameter list begins to display. The default display at start up is always the Parameter List.

Press both arrows simultaneously and then release to reach the **Main Menu**. Use the **Up** and **Down Arrows (buttons)** to scroll through the items.

The **Main Menu** consists of *Show 1-up, Active Faults, Stored Faults, Set Units, Set 1-up, Scroll ON/OFF, Machine Hours ON/OFF, Tier 4 ON/OFF, Set Tier 4, and Backlight*. To **return** to the **Parameter** list, scroll to **Show 1-up** and momentarily press both arrows, release and parameter readings begin to display.

Menu Item	Options	Action
Show 1-up	Switch to the parameter display.	Momentarily hold the Up & Down arrows, when released, broadcast parameters begin to display.
Active Faults	 <p>The Active Fault (Active FLTS) menu shows the SPN (Suspect Parameter Number), FMI (Failure Mode Identifier), and OC (Occurrence Count) for faults currently broadcasting on the CANBus.</p> <p>When a new fault message is received, the PV25 automatically switches to Active Faults.</p>	<p>The Amber (left) or Red (right) LED lights to indicate the status of the fault – Warning or Shutdown.</p> <p>If there is more than one fault, the PV25 automatically scrolls through each fault.</p> <p>To return to the Main Menu press the Up & Down arrows simultaneously and release.</p>

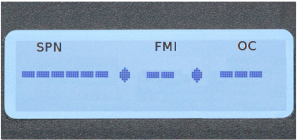
Menu Item	Options	Action
<p>Stored Faults</p>	<p>The Stored Faults (Stored FLTS) menu shows the SPN, FMI, and OC for any stored faults. A message is sent to the ECU, and the ECU responds with what is in history.</p> <p>If there are no stored faults, you will see this:</p> 	<p>Use the Up & Down arrows to scroll through the list if there is more than one stored fault.</p> <p>To return to the Main menu press the Up & Down arrows simultaneously and release.</p>
<p>Set Units</p>	<p>The Set Units Config menu will allow the user to select between the following unit settings:</p> <p>English Metric kPa Metric BAR Exit</p> <p>An asterisk to the right of a setting indicates it is the current setting.</p>	<p>To enter the Set Units menu, momentarily press both arrows and release. Scroll through the options using the Down arrow.</p> <p>Choose a unit by momentarily pressing the Up/Down arrows. An asterisk displays at the right.</p> <p>To leave this menu, scroll down to EXIT, press both arrows and release.</p>

Menu Item	Options	Action
Set 1-up	<p>Use this menu to set the parameters you want to monitor. For a full list of the parameters available, see page 6.</p> <p>An (*) asterisk to the right of the parameter indicates it is selected.</p>	<p>Pressing the Up/Down arrows at the same time selects the currently displayed parameter.</p> <p>Pressing the Up/Down arrows at the same time while Exit is displayed returns you to the main menu. Exit is the last item in the parameter list.</p>
Scroll ON/OFF	<p>When Scroll is ON, the Parameters you selected to display automatically scroll with about 5 seconds on each parameter reading. If Scroll is OFF, view parameters manually by pressing the Up or Down arrow.</p>	<p>To toggle ON or OFF, press the Up/Down arrows at the same time.</p>
Machine Hours ON/OFF	<p>When set to ON, machine hours are calculated by the PV25 once the RPM is above 100.</p>	<p>Scroll to Machine Hours. To toggle ON or OFF, press the Up/Down arrows at the same time.</p>
Tier 4 ON/OFF	<p>When Tier 4 is set to OFF, other Tier 4 menu items are not available.</p> <p>For more information about Tier 4, see Tier 4 and EU Emissions Standard – Stage IIIB on page 8.</p>	<p>To toggle ON or OFF, press the Up & Down Arrows at the same time.</p> <p>If Tier 4 is ON, and there is Tier 4 activity, the Tier 4 symbols show at the left of the screen beside the parameter data.</p>

Menu Item	Options	Action
Set Tier 4	<p>Auto – Automatically displays all Tier 4 information (symbols) from the CAN and allows for Auto Regeneration of a Tier 4 engine through CAN messaging.</p> <p>Request – Sends a request to the ECU to perform a regeneration.</p> <p>Inhibit – Sends a message to the ECU to prevent a regeneration from occurring.</p> <p>None – Not sending any Tier 4 messages.</p> <p>Exit – Return to the Main menu.</p>	<p>Momentarily press the Up & Down arrows to reach the Tier 4 menu. Select and set a Tier 4 choice by pressing the Up/Down arrows. An asterisk shows next to the selection.</p>
Backlight	<p>The Backlight menu allows you to select the desired backlight level. The range is 0-100% and it changes in 5% increments. This value also broadcasts a CAN message that can set the backlights on optional PVCAN gauges in the panel to the same intensity.</p>	<p>Pressing the Up/Down buttons at the same will toggle into and out of the adjustment screen.</p>

Parameter Menu

The following lists the parameters that can be viewed on the PV25.

PGN	Description	Notes
Internal	Machine hours	If set to OFF, the machine hours do not increment. However, if at any point machine hours were accumulated, that hour value maintains through power cycles.
61444	Engine Speed (Eng RPM)	
65263	Engine Oil Pressure (Oil Pres)	
65262	Engine Coolant Temperature (Cool Tmp)	
65271	Voltage (Sys Volt)	
65271	Battery Potential (Switched) (Bat Volt)	
65253	Total Engine Hours (Eng Hrs)	
61443	Percent Load at Current RPM (Load @ RPM)	
65257	Total Fuel Used	
65266	Average Fuel Economy (Avg Econ)	
65257	Trip Fuel	
65262	Engine Oil Temperature(Oil Temp)	
65270	Exhaust Gas Temperature (Exh Tmp)	
65270	Air Filter Differential Pressure (AirDifPr)	
64891	Percent Soot (Soot Lvl)	Only available if Tier 4 is ON in the Main menu.
65110	Catalyst Temperature (Cat Temp)	Only available if Tier 4 is ON in the Main menu.
64891	Percent Ash (Ash Lvl)	Only available if Tier 4 is ON in the Main menu.
64947	Exhaust Filter Outlet Temp (ExOutTmp)	Only available if Tier 4 is ON in the Main menu.
64948	Exhaust Filter Inlet Temp (ExhInTmp)	Only available if Tier 4 is ON in the Main menu.
65110	Catalyst Tank Level (DEF Lvl)	Only available if Tier 4 is ON in the Main menu.

Faults, Warnings and Indicators

The PV25 provides two means for displaying faults and warnings: visual LEDs on the casing (*Amber* at the upper left, and *Red* at the upper right), and **Active Warning** screens listing the SPN, FMI, and OC. In addition, **Tier 4/Euro State IV** symbols display to indicate Tier 4 status if Tier 4 is set to **ON**.

Visual Indication

- Amber LED (Warning)
- Red LED (Derate / Shutdown)

Indicators for Active Fault Codes

Tier 4 Indicators display at the left of the screen. The current gauge readings continue to display on the right.

Warning or Shutdown Screens



Active Shutdown or Warning screens display when a fault occurs. The screen lists the SPN, FMI, and Occurrence Count. If there is more than one fault, PV25 automatically scrolls through all faults.

DM13 – Start/Stop Broadcast:

This message is used to stop or start broadcast messages and may not completely prevent all messages. Critical messages indicating unsafe or damaging operating conditions will still be seen and require a response. The DM13 can only be initiated when the engine is at zero RPM. DM13 is used when diagnostic procedures are performed.

PV25 responds to an incoming DM13 message by suspending outgoing data transmissions. To maintain a suspended transmission event, the hold signal must be sent once every 5 seconds. If the hold signal disappears for more than 6 seconds, the system reverts to a normal state.



Tier 4 and EU Emissions Standard – Stage IV

*Murphy products are compliant with requirements for U.S. EPA Emission Standard Tier 4 and EU Emissions Standard Stage IV for diesel engines. These engines when fitted with a DPF (Diesel Particulate Filter) can self-clean the filter of particulates. This self-cleaning is known as Regeneration. PV25 offers 4-CAN options when regeneration is enabled and available in the engine ECU. For more information, see the Tier 4 Overview document (1110836) under **PV25 Literature** on the Murphy Web site (www.murphybynovationcontrols.com).

Tier 4 must be set to **ON** in the **Main** menu. If Tier 4 is **ON**, and there is Tier 4 activity, the Tier 4 symbols show at the left of the screen beside the parameter readings.

The following ISO symbols indicate regeneration status.

DPF Regen ISO Symbols

Icon	PGN	SPN	Description
	64892	3697	High Exhaust Temperature (HEST) lamp indicates regeneration in process.
	64892	3703	DPF Particulate Filter Restricted lamp indicates a Regen is needed. NOTE: If the filter restriction reaches a critical level, this symbol begins to flash.
	64892	3698	DPF Inhibit lamp indicates an inhibited Regen status.

Mounting and Installation

Product Dimensions

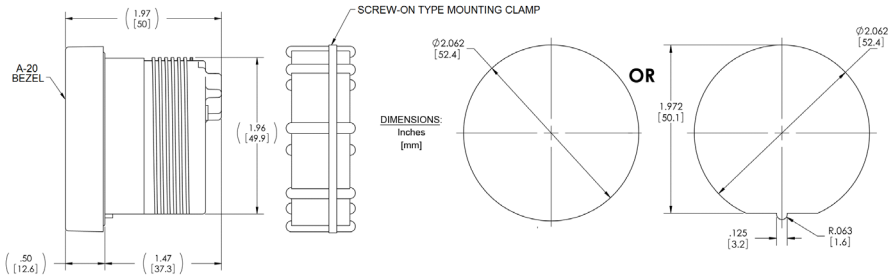

Connection Detail

PV25 Back View

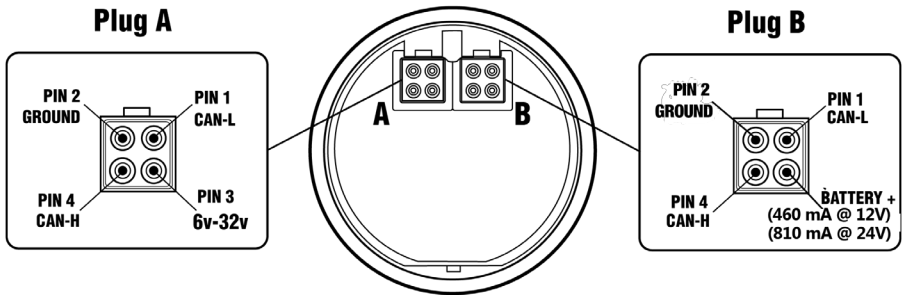

Typical Wiring Diagram

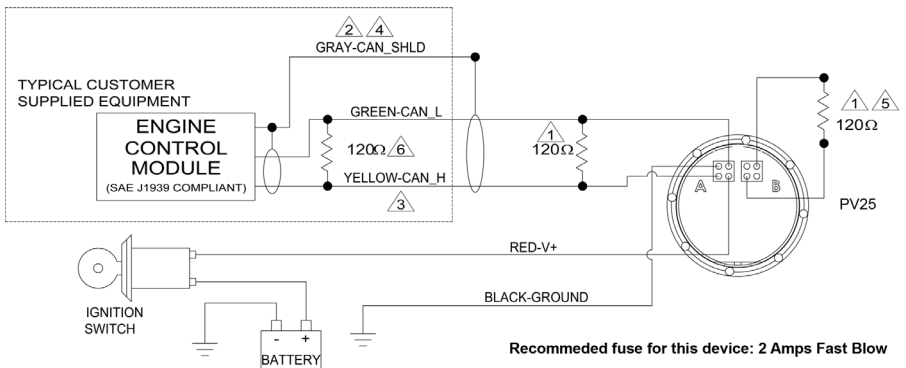

WARNING! READ NOTES below before installing the PV25.

Note	
⚠	Use resistor between CAN_H and CAN_L line near PowerView (included in some cables or factory purchased panels). Resistor can be installed in the wire harness attached to Port A or a terminating resistor (Murphy P/N 7800480) can be attached to Port B. Do not connect a terminating resistor to Port A and B simultaneously. If PV25 is not the last device on the CAN bus, place terminator resistor at last CAN device.
⚠	Use SAE J1939 CAN compliant wiring.
⚠	Only use 120 OHM characteristic impedance cable, ex. Belden 9841.
⚠	CAN Shield connected to ECU end only.
⚠	Do not connect to PV25 Port B other than to terminate CAN bus. See Note 1.
⚠	Terminating resistor at ECU end of harness. WARNING: Two 120 Ohm resistors should be located at opposite ends of the J1939 CAN bus. Failure to comply will cause bus failures. Only two 120 Ohm resistors are allowed on the J1939 CAN bus. ECU terminating resistor is typically located in the harness, but can be located inside the ECUs. For ECU resistor location check with OEM, equipment supplier, or ECU specification.

Specifications

Operating Voltage: 6.0 VDC minimum to 36 VDC maximum

Power Supply Operating Current:

460mA max @ 12VDC

810mA max @ 24VDC

Reversed Polarity: Withstands reversed battery terminal polarity indefinitely within operating temperature.

Environmental

Operating Temperature: -40°C to 70°C (-40°F to 158°F)

Storage Temperature: -55°C to 85°C (-67°F to 185°F)

Sealing: IP68

CAN Bus: SAE J1939 compliant

Connectors

4-pin AMP "Mini-universal Mate-N-Lok connector"

AMP Plug: P/N 172338-1

AMP Socket: P/N 171639-1 (4 each, assumes 18 gauge wire. See AMP Plug specification to match socket and wire size.)

Maximum Panel Thickness: 3/8 inch (9.6 mm)

Shipping Weights (all models): 0.2 lb. (0.1 kg.)

Shipping Dimensions (all models): 3-7/8 x 2-3/4 x 2-3/4 in. (98.4 x 69.85 x 69.85 mm)

In order to consistently bring you the highest quality, full-featured products, we reserve the right to change our specifications and designs at any time. MURPHY products and the Murphy logo are registered and/or common law trademarks of Enovation Controls, LLC. This document, including textual matter and illustrations, is copyright protected by Enovation Controls, LLC, with all rights reserved. (c) 2018 Enovation Controls, LLC. A copy of the warranty may be viewed or printed by going to www.enovationcontrols.com/warranty

ENOVATION CONTROLS CORPORATE HEADQUARTERS
5311 S 122ND EAST AVENUE
TULSA, OK 74146

ENOVATION CONTROLS LTD. -- UNITED KINGDOM
CHURCH ROAD LAVERSTOCK
SALISBURY SP1 1GZ UK

SUN MURPHY INTERNATIONAL TRADING (SHANGHAI) CO., LTD
815 ROOM 6F BUILDING, 351 SIZHUAN ROAD
SONGJIANG DISTRICT, SHANGHAI 201601, CHINA

ENOVATION CONTROLS INDIA PVT. LTD.
301, 3RD FLOOR, KRISNA CHAMBERS,
11 GALAXY GARDENS, NORTH MAIN ROAD,
KOREGAON PARK, PUNE 411001,
MAHARASHTRA, INDIA

U.S. SALES & SUPPORT

PHONE: 918 317 4100
EMAIL: SALES@ENOVATIONCONTROLS.COM
WWW.ENOVATIONCONTROLS.COM

MURPHY INDUSTRIAL PANEL DIVISION

PHONE: 918 317 4100
EMAIL: IPDSALES@ENOVATIONCONTROLS.COM

INTERNATIONAL SALES & SUPPORT

EUROPE, MIDDLE EAST, AFRICA
PHONE: +44 1722 410055
EMAIL: SALES@ENOVATIONCONTROLS.EU

CHINA
PHONE: +86 21 6237 5865
EMAIL: AFSALES@ENOVATIONCONTROLS.COM

INDIA
PHONE: +91 91581 37633
EMAIL: INDIASALES@ENOVATIONCONTROLS.COM



FM 28221 (Tulsa, OK - USA)
FM 28422 (UK)