

# AS3000 Engine/Generator Controller

yi6234  
revision B, 19<sup>th</sup> January 2006  
catalogue section 40

## Installation Instructions

**MURPHY**

Please read the following information before installing. A visual inspection of this product for damage during shipping is recommended before installation. It is your responsibility to ensure that qualified mechanical and electrical technicians install this product. If in doubt, please contact your local Murphy representative.

### GENERAL INFORMATION

# WARNING

**BEFORE BEGINNING INSTALLATION OF THIS MURPHY PRODUCT**

- ✓ Disconnect all electrical power to the machine
- ✓ Make sure the machine cannot operate during installation
- ✓ Follow all safety warnings of the machine manufacturer
- ✓ Read and follow all installation instructions

### Description

The AS3000 provides control circuitry for the automatic or manual starting and stopping of a diesel generator, pump or other engine driven equipment. A basic AS3000 system comprises two modules:-

- **AS3000U** – A User Interface Module, mounted in the front of a control panel. Each module consists of 3 operator control keys, LEDs for status and fault indication, and electrical connectors for front-of-panel equipment.
- **AS3000P** – A Panel Interface Module, designed for DIN rail mounting inside the panel. This module contains the main control circuitry and electrical terminals for connection with an engine wiring harness.

The two modules are connected by a single communications lead. The two-part design may be used to reduce wiring between engine cables and front-of-panel user controls.

This document details the installation and operation of the AS3000 system. Additional information about the AS3000 may be found in the following documents:

Doc. ref.	Title
ms5261	AS3000 bulletin

The above information is available on request from your Murphy representative, or from the 'products' section of our website [www.fwmurphy.co.uk](http://www.fwmurphy.co.uk)

### Specification

#### Power supply:

Continuous voltage range	8 – 35 VDC
Brown out voltage	5 VDC for 2 secs (recovery to 8V)
Blackout voltage	0V for 50mS (from 10V, recovery to 5V)
Overvoltage withstand	50 VDC for 5 seconds (to SAEJ1810 load dump immunity)
Reverse voltage withstand	100 VDC continuous
Current consumption (standby)	50mA
Current consumption (max)	500mA (plus output loads)

#### DC Inputs:

Oil pressure, coolant temp, auxiliary and charger faults	closed to negative DC ( $\pm 3V$ ) on fault
Remote start positive	open from positive DC to start
Remote start negative	close to negative DC ( $\pm 3V$ ) to start
Lamp test	close to negative DC ( $\pm 3V$ ) to activate
DC input protection	$\pm 50$ VDC max.

#### AC Inputs:

Magnetic pickup	3 – 60 VAC, 200 Hz – 10 kHz.
Generator AC	80 - 600 VAC (L-L or L-N), 50/60 Hz.

#### Outputs:

Fuel	positive DC (semiconductor), 5A max.
Crank, preheat	positive DC (semiconductor), 2A max.
Common alarm, fault lockout	negative DC (semiconductor), 300mA max.
Generator Hz. meter	0 – 5VDC (@ 45–65Hz), 10mA max

#### Physical:

Dimensions	see overleaf
Operating temperature	-10 to +65°C
Relative humidity	95% @ 60 °C
Environmental protection	AS3000U front: IP65, NEMA4
Vibration	ISO 88528 pt.9, & 3 axis 3g
Weight	AS3000U: approx. 250g AS3000P: approx. 160g

**MURPHY**

**FW Murphy**  
PO Box 470248  
Tulsa, Oklahoma 74147, USA  
tel: +1 918 317 4100  
fax: +1 918 317 4266  
email: [sales@fwmurphy.com](mailto:sales@fwmurphy.com)  
web: [www.fwmurphy.com](http://www.fwmurphy.com)

**CONTROL SYSTEMS & SERVICES DIVISION**  
PO Box 1819, Rosenberg, Texas 77471, USA  
tel: +1 281 633 4500  
fax: +1 281 633 4588  
email: [sales@fwmurphy.com](mailto:sales@fwmurphy.com)

**MURPHY DE MEXICO S.A. DE C.V.**  
Bld. Antonio Rocha Cordero 300, Fracción del  
Aguaje San Luis Potosí, S.L.P. México 78384  
tel: +52 444 8206264  
fax: +52 444 8206336  
Villahermosa office tel: +52 993 3162117  
email: [ventas@mex.murphy.com](mailto:ventas@mex.murphy.com)  
web: [www.murphy.com.mx](http://www.murphy.com.mx)

**INDUSTRIAL PANEL DIVISION**  
PO Box 470248  
Tulsa, Oklahoma 74147, USA  
tel: +1 918 317 4100  
fax: +1 918 317 4266  
email: [sales@fwmurphy.com](mailto:sales@fwmurphy.com)  
web: [www.fwmurphy.com](http://www.fwmurphy.com)

**FRANK W. MURPHY LTD.**  
Church Rd, Laverstock, Salisbury, SP1 1QZ, UK  
tel: +44 1722 410055  
fax: +44 1722 410088  
email: [sales@fwmurphy.co.uk](mailto:sales@fwmurphy.co.uk)  
web: [www.fwmurphy.co.uk](http://www.fwmurphy.co.uk)



## GENERAL INFORMATION (cont.)

### Anti-static precautions

The AS3000 features sensitive electronic components that may be damaged by static discharge. We therefore recommend that anti-static precautions are observed when storing, unpacking and handling the AS3000:-

- Store AS3000 modules in the packing provided
- Use earthed wrist straps and anti-static mats when handling and during installation.
- Handle each module at the edges, using the plastic mouldings. Where possible, avoid physical contact with exposed circuit boards and electrical connectors.

### Unpacking

Each AS3000 system comprises the following components:-

- AS3000P panel interface module (stock code 41.70.0097), with 9 circuit board links for setting operating options.
- AS3000U user interface (front of panel) module, complete with fixing clamp and nuts. There are two standard variations:-

*Stock ref. Description*

41.70.0095 AS3000U, international symbol front facia

41.70.0096 AS3000U, US English text front facia

The AS3000U is usually supplied pre-fitted with communication lead AS3000L (stock code 41.70.0098).

- These installation instructions

### System Overview

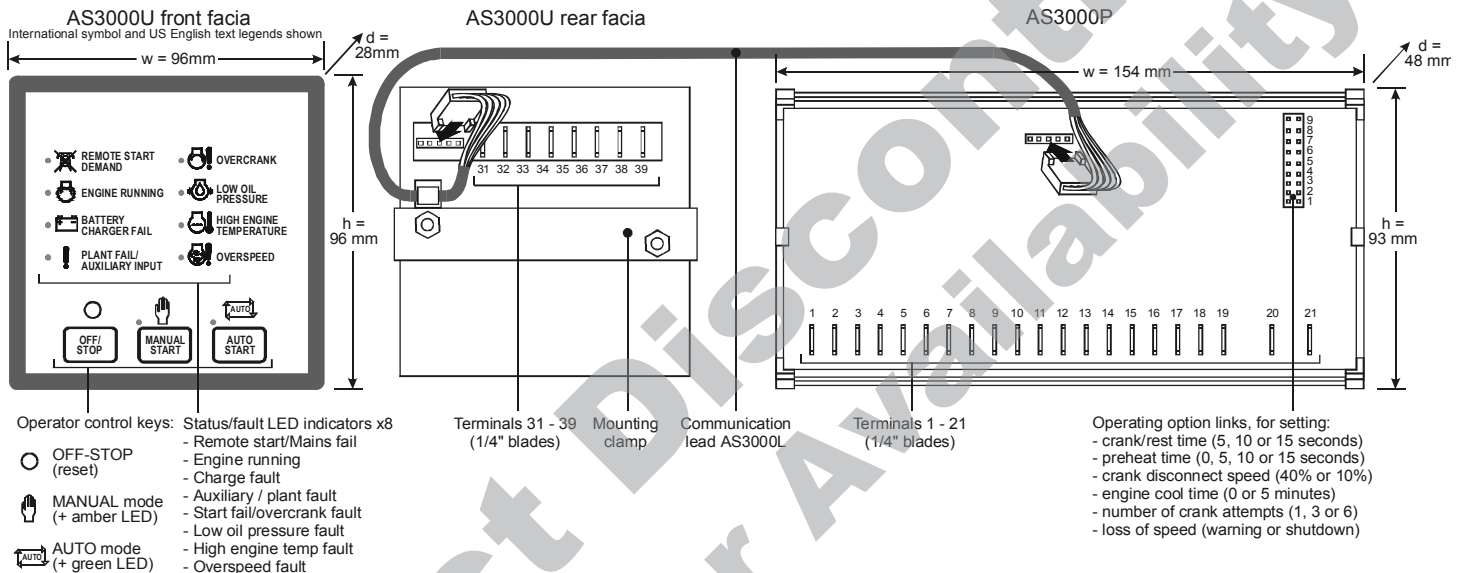

### MOUNTING INFORMATION

#### AS3000U user interface module

The AS3000U is mounted in the front of a control panel through a 92mm square (DIN standard) cut-out:-

- Remove the two fixing nuts and clamp at the module rear.
- From the panel front, insert the unit into the cut-out (A)
- Refit the mounting clamp (B) and nuts (C). Before fully tightening the nuts, ensure that the unit and its integral sealing gasket are squarely located in the cut-out.

The module extends 20 mm behind the panel front, but a minimum of 40mm should typically be allowed where (optional) panel wiring is used.

#### AS3000P panel interface module

The plastic mouldings on either side of the AS3000P are designed to allow snap-mounting to a control panel DIN rail (e.g. Murphy part number 40-05-0474):-

- Locate each moulding on to the top edge of the DIN rail (A).
- Push the edges of the module (B) so that the lower part of the moulding snaps on to the lower edge of the DIN rail (C).
- To release the module, apply pressure (e.g. with fingers or a levered screwdriver) to the flexible section of both mouldings (D), pull the module outwards (E) and off the rail.

# FUNCTION SETTINGS

## PCB links

The AS3000 has a number of operating options, set by 9 links on the AS3000P circuit board.

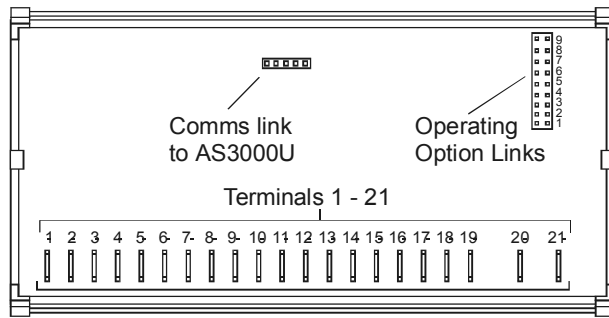

The links must be set correctly before the AS3000 is connected or used.



**WARNING: incorrect settings may cause maloperation or damage to engine and plant.**



**WARNING: we recommend that anti-static precautions (as detailed above) are observed during the fitting or removal of PCB links.**

Add or remove links as shown in the table opposite. Note that standard units are supplied with all links fitted.

Function	Links	Option	Factory Default
Crank/rest time	1	2	
	✓	✓	10 secs
	✗	✓	15 secs
	✗✓	✗	5 secs
Preheat time	3	4	
	✓	✓	0 secs (no preheat)
	✗	✓	5 secs
	✓	✗	10 secs
	✗	✗	15 secs
Crank disconnect speed	5		
	✓		40% of nominal
	✗		10% of nominal
Engine cool time	6		
	✓		0 minutes
	✗		5 minutes
Number of crank attempts	7	8	
	✓	✓	3 attempts
	✗	✓	6 attempts
	✗✓	✗	1 attempt
Loss of speed signal response	9		
	✓		shutdown
	✗		warning (alarm) only

# ELECTRICAL CONNECTION



**WARNING: DANGER OF INJURY OR DEATH. For certain operating configurations, the AS3000 includes connection of high voltage AC supplies. Before connection, disconnection or handling of the AS3000, ensure that all AC and DC power supplies are isolated. Connection to or disconnection from live wiring can also cause damage to AS3000 internal components.**

## General

Electrical connection on both AS3000 modules is via 1/4" (6.3mm) blade terminals. Murphy make the following general connection recommendations:-

### Battery chargers

Some battery chargers feature significant ripple and switching noise on the DC output. This electrical interference can be imposed on the panel power supply and control lines, with the potential to cause faulty operation of (and in extreme cases damage to) electronic control equipment.

Minimise the effects of charger output noise by using separate wiring 1) between charger output and battery terminals and 2) between battery terminals and panel DC supply rail.

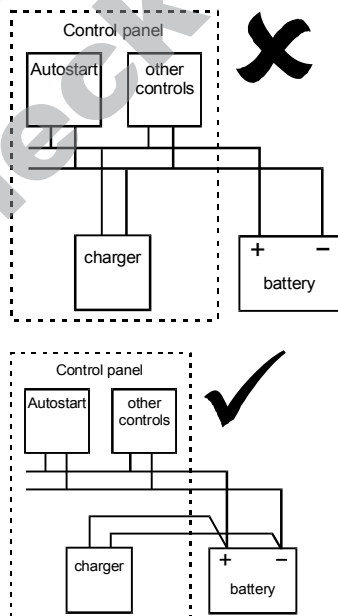

**External Slave Relays** are a recommended connection on all outputs (as shown right), either to achieve the required load switching capability, or to reduce wear and tear on internal relay contacts.

**Slave relay and solenoid coils** will naturally emit voltage spikes when de-energising, with the potential to cause maloperation of, or damage to, electronic equipment.

Suppress relay and solenoid coils at source, using the manufacturer's recommended suppression network. DC coiled relays may also be suppressed using a reversed biased flywheel diode as shown right.

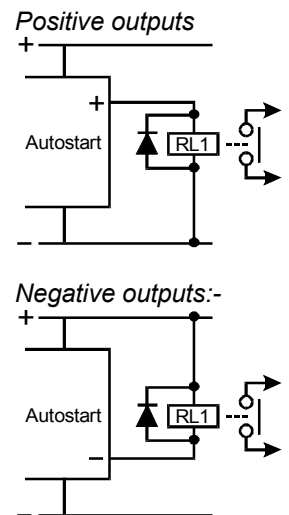

## ELECTRICAL CONNECTION (cont.)

A typical wiring diagram for the AS3000 is shown in the panel opposite.

### Electrical Connection, AS3000P

Connection is via 6.3mm (1/4") blade terminals on the main circuit board, numbered 1 – 21:-

#### 1 Negative DC power supply

#### 2 Positive DC power supply

The power supply for the AS3000. Steady state operating voltage range is 8 – 35 VDC. See specification for high and low voltage withstand thresholds.

#### 3 Preheat Output

#### 4 Crank Output

#### 5 Fuel Output

Connect these (semiconductor based) outputs to engine preheat, starter motor and fuel circuits. Each terminal gives a positive DC output when active.

The fuel output is designed for use with energised to run fuel solenoids, and is rated to 5 Amps. The crank and preheat outputs are each rated to 2 Amps.

Slave relays with suppressed coils should be wired between each output and battery negative, with the slave relay contacts used to drive fuel/starter solenoids and preheat circuits.

#### 6 Charge alternator D+ or WL

Pin 6 may be connected to the D+ or WL (warning lamp) terminal of an engine driven charge alternator. The AS3000 provides the necessary current required to excite the alternator, and measures the D+/WL terminal voltage. Once the engine is running and the fault lockout time has expired, the front facia charge fail LED will light if the D+/WL voltage falls below approx. 9.5 volts.

#### 7 Fault lockout output

#### 8 Common alarm output

Both these outputs are semiconductor based, providing a negative DC output when active. The outputs are able to sink up to 300mA max., and are typically used to drive a panel relay (as shown on page 3).

The fault lockout output activates after the fault lockout time has expired (15 seconds after an engine start). The common alarm output activates during fault conditions.

#### 9 Remote start input (negative)

With the AS3000 in Auto mode, close this input to battery negative to initiate an automatic engine start. Make the input open circuit to return the system to standby mode.

See also pin 16 (remote start input positive).

#### 10 Low Oil Pressure (LOP) input

#### 11 Charger Fail input

#### 12 High Engine Temperature (HET) Input

#### 13 Auxiliary fault / Plant fail input

#### 14 Overspeed input

These inputs are used with remote fault switches/contacts to trigger fault conditions. To trigger a fault, each input must be closed to battery negative DC.

An active Low Oil Pressure, High Engine Temperature or Auxiliary Fault input will cause an immediate engine shutdown. Oil pressure and engine temperature inputs do

### Typical Wiring Diagram

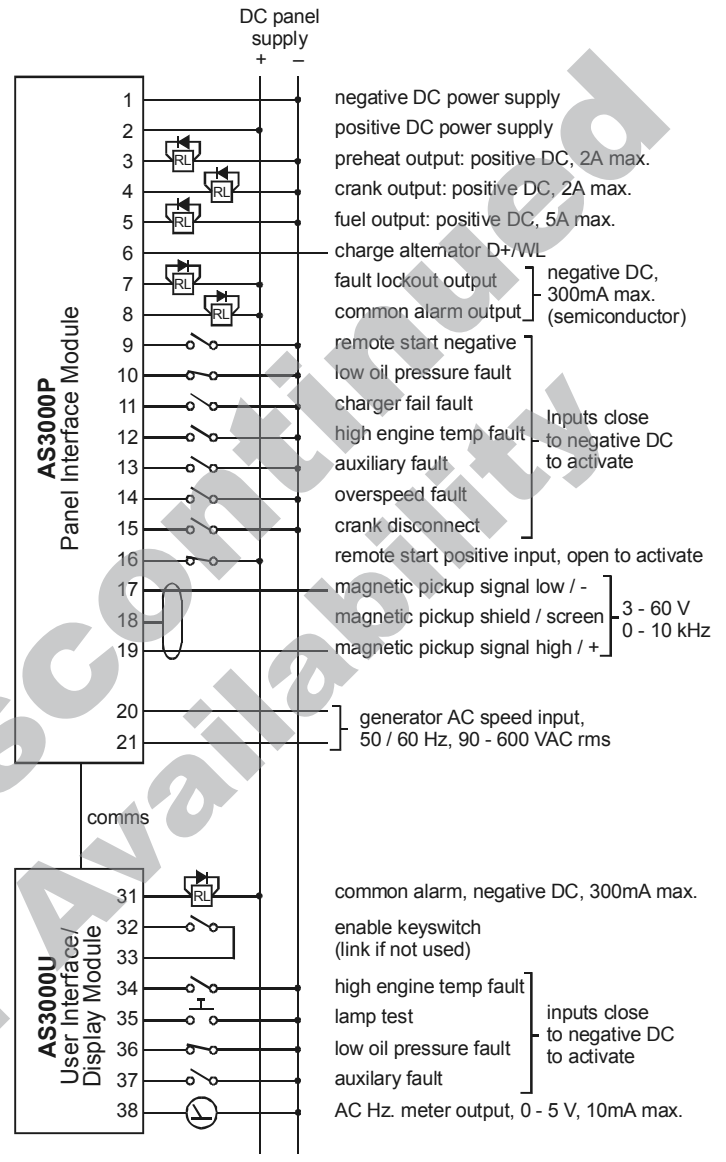

not operate while the engine is stationary, during engine starting, or until the fault lockout timer has expired (15 seconds after engine starting). The Auxiliary fault input may be activated at any time: if the fault occurs while the engine is stationary, the AS3000 inhibits engine starting.

The Overspeed input allows an immediate shutdown to be externally triggered at any point after engine starting. This input is provided in addition to the on-board overspeed measurement and tripping.

The Charger Fail input may be activated at any time, causing the charge fail LED to light. The AS3000 does not shutdown the engine nor inhibit an engine start.

All the above fault conditions will cause the operation of the common alarm outputs (pins 8 and 31).

Note that some of the above inputs are duplicated on the user interface module, allowing optional, more convenient wiring to front facia mounting equipment (e.g. Murphy Swichgages®). See AS3000U connection below for full details.

### 15 Crank disconnect input

The AS3000 may be configured to measure engine speed using a magnetic pickup or AC Hz. signal, and to disconnect cranking once the engine is running.

Alternatively, pin 15 may be used to trigger a crank release from an external contact (e.g. a remote speed trip). To disconnect the starter, connect pin 15 to battery negative.

### 16 Remote start input (positive)

With the AS3000 in Auto mode, make this input open circuit to initiate an automatic engine start. To return the system to standby mode, close this input to battery positive DC.

See also pin 9 (remote start input negative).

### 17 Magnetic pickup speed input negative

### 18 Magnetic pickup speed input screen / shield

### 19 Magnetic pickup speed input positive

The signal from an engine mounted magnetic pickup may be used to sense engine speed. The pickup negative and positive output terminals should be respectively connected to pins 17 and 19. (*Note: the polarity of connection is not usually important if the pickup head is isolated from the pickup body and ground.*) The connection between pickup and AS3000 should use a two-core and screen cable. The cable screen should be connected at the AS3000 end only, to pin 18.

If pins 17 – 19 are connected, pins 20 and 21 (generator AC speed sensing) must be left open circuit. Note that the speed sensing circuit must be calibrated before the AS3000 can be used - see 'speed calibration' below.

### 20 AC speed input

### 21 AC speed input



#### WARNING: HIGH VOLTAGE - DANGER OF INJURY OR DEATH.

- Ensure that all AC power supplies are isolated before connection, disconnection or handling.
- Use fully shrouded wiring connectors on these terminals.

These terminals allow measurement of engine speed using a generator AC signal (nominal 50 or 60 Hz).

The input may be connected to generator line to neutral or line to line voltage, maximum 600 VAC. If pins 20 and 21 are connected, pins 17, 18 and 19 (magnetic pickup speed sensing) must be left open circuit.

Before the AS3000 can be used, this circuit must be correctly calibrated - see 'speed calibration' below.

## Electrical Connection, AS3000U

Connection to the User Interface module is via 8 blade terminals (1/4" / 6.3mm). Some of the terminals duplicate features found on the AS3000P Panel Interface unit, allowing optional, more convenient connection to local, front-of-panel equipment.

### 31 Common alarm output

Connection and operation is identical to AS3000P pin 8.

### 32 Keyswitch

### 33 Keyswitch

Use these terminals to restrict AS3000 operation via a Keyswitch or other remote contact. The system will only operate while these pins are connected. If this feature is not used, connect pins 32 and 33 using the wire link supplied.

### 34 High Engine Temperature Fault Input

### 36 Low Oil Pressure Fault Input

### 37 Auxiliary Fault / Plant Fail Input

Operation is identical to AS3000P inputs 12, 10 and 13. The fault inputs may be used instead of, or in addition to, the Panel Interface inputs, e.g. where front of panel Murphy Switchgear® units are used for pressure and temperature monitoring.

### 35 Lamp Test

Close this input to battery negative to light all the front fascia LEDs. This input is typically used with a front of panel, momentary action push button.

### 38 Analogue Speed Output, 0 – 5 VDC

When engine speed is measured from the generator AC (via pins 20 and 21), pin 38 may be used to drive a suitably scaled 'generator Hz.' meter.

The meter must have a 0 – 5 V DC movement, with scale 45 – 65 Hz. Connect the meter between pin 38 and battery negative. The output will support a maximum meter load of 10mA.

## Communication link

Communication between AS3000U and AS3000P modules is via a short 1.3 metre lead, model reference AS3000L. Electrical connection is via 5 male pin headers (on each module) and female connector blocks (at each end of the lead).

The AS3000U is normally supplied with the communication lead pre-connected. If the lead needs to be disconnected, ensure that the lead connector block is correctly orientated during reconnection: the correct orientation is shown on page 2, and on the product label. Note: incorrect connection will not damage the AS3000, but will result in non-operation.

At the AS3000P end, both lead connector block and male pins are polarised, ensuring correct connection. The correct orientation is again shown on page 2 and on the product labelling.

# SPEED CALIBRATION

## General

The AS3000 is able to sense engine speed from one of two methods, magnetic pickup or generator AC frequency.

Either (but not both) of these circuits may be used to trigger the automatic crank release and overspeed fault shutdown.

Before use, the AS3000 **MUST** be correctly calibrated to recognise the engine 'normal' running signal.



**WARNING: incorrect calibration may cause faulty operation or damage to engine and plant.**

Calibration is typically carried out after connection into the control panel, during engine commissioning. Alternatively, e.g. when an engine is not available, calibration may be performed 'on the bench', by simulating the speed signal (either magnetic pickup or generator AC).

### Entering calibration mode

- Ensure that all electrical connections are made
- Press and immediately release the **MANUAL**/ key.

If the AS3000 speed calibration has not previously been set, the unit will automatically adopt calibration mode (indicated by a flashing manual LED) – continue set up from 'crank disconnected set-up' below.

If the speed calibration has already been set, the manual LED will light continuously. To recalibrate the unit, e.g. for another type of engine, enter calibration mode as follows:-

- Press and hold the **OFF-STOP**/ key
- Press and hold the **MANUAL**/ key until the amber LED flashes.
- Release the **OFF-STOP**/ and **MANUAL**/ keys.

To exit calibration mode at any time, press **OFF-STOP**/. The previous calibration setting will then be restored.

### Crank disconnect set-up

With calibration mode selected (amber Manual LED flashing), automatic crank disconnect is inhibited.

Start the engine as follows:-

- Press and hold the **MANUAL**/ key. If a preheat option has been set, the preheat output will operate for the selected time before engine cranking. Maintain the **MANUAL**/ key through the preheat time and during cranking.
- Release the **MANUAL**/ key when the engine fires.

Once the AS3000 detects a speed signal, the **ENGINE RUNNING**/ LED will flash. At this point, the engine speed governor may require adjustment to ensure correct engine running.

Once the engine has stabilised to normal running speed:-

- Press and immediately release the **MANUAL**/ (manual) key. If a normal running speed signal is present, the crank release speed is set to 10% or 40% of the normal running speed (depending on the setting of link 5). If no speed signal is present, the AS3000 is set for crank release by use of external contact (using pin 15).

Once the crank disconnect set up is complete, the **ENGINE RUNNING**/ LED will light continuously, and the **OVERSPEED**/ LED will flash to indicate...

### Overspeed trip set-up

In this set-up mode, both **MANUAL**/ key and **OVERSPEED**/ LEDs flash, and the **ENGINE RUNNING**/ LED is lit continuously. With the engine running at normal speed:-

- Press and immediately release the **MANUAL**/ key. The engine stops, and the overspeed trip is set to give an immediate shutdown at 115% of the measured (nominal) speed, and a 3 second delayed shutdown at 110% nominal. If no speed signal is present when the **MANUAL**/ key is pressed, the overspeed trip is set to operate using the overspeed input (pin 14).

Once the engine has stopped, the engine running and overspeed LEDs go out, but the manual LED should stay flashing. To exit set up mode and save the calibration changes, press **OFF-STOP**/.

## OPERATION

### Operation

User control of the AS3000 and engine is through the three front facia operating mode keys:-

#### OFF-STOP (reset)/○

Press this key to power down the AS3000, stop the engine and reset latching shutdown faults.

#### AUTO START/



Press this key to select Auto mode. A green LED lights continuously when Auto this mode is selected.

In Auto mode, the AS3000 will automatically preheat, start, run and stop the engine in response to the remote start contact(s) - see 'electrical connection' above for pins 9 and 16. The AS3000U front facia  (remote start/mains fail) LED lights to indicate when the engine is 'on demand'.

#### MANUAL START/

Use this key to give manual mode control over engine starting and running.



If the engine is stationary – i.e. if the AS3000 is in Off-stop or Auto standby modes – use this key to start the engine:-

- Press and immediately release the **MANUAL/** key. The AS3000 adopts manual mode (indicated by the amber LED), turns on the engine fuel, but (provided the key is released immediately) does not crank the engine.
- To (preheat and) crank the engine, press and hold the **MANUAL/** key for at least 1 second. If a timed preheat option has been selected, the preheat output will activate. At the end of the preheat time, or if preheat has been turned off, the start output will operate. The start and preheat outputs will only operate while the **MANUAL/** key is held down and the engine speed is below the pre-calibrated crank release level. If the key is released, or if the engine speed rises above the automatic crank release level, the AS3000 disconnects the starter (and preheat), but maintains the engine fuel.

If the AS3000 is already running the engine in Auto mode, the **MANUAL/** key allows the operator to maintain engine running indefinitely:-

- Press and release the **MANUAL/** key; the amber manual mode LED will light. The AS3000 will then ignore the state of the remote start inputs and will run the engine continuously.

To stop the engine, the operator has 2 options:-

- Press the **OFF-STOP/** key. The AS3000 will stop the engine immediately.
- Press the **AUTO/** key. Engine stopping (and restarting) then reverts to the control of the remote start inputs.

### Responding to faults

In Auto and Manual modes, the AS3000 continuously monitors for engine and plant faults.

The operator is typically warned of faults by use of an audible alarm, driven from the AS3000 'common alarm' output (see 'electrical connection' details for pins 8 and 31). Once alerted, the operator can identify fault and

system status using the front facia LEDs:-



**REMOTE START** (mains fail) input active



**ENGINE RUNNING**



**CHARGE FAIL** fault



**PLANT FAIL / AUXILIARY INPUT** fault



**OVERCRANK** (start fail) fault



**LOW OIL PRESSURE** fault



**HIGH ENGINE TEMPERATURE** fault



**OVERSPEED** fault. Flashing LED indicates speed signal failure

### Shutdown faults

Start fail/overcrank, low oil pressure, high engine temperature, auxiliary fault and overspeed alarms cause an immediate shutdown and/or lockout of the engine. These faults operate on a latching, 'first-up' indicated basis.

Overspeed monitoring begins immediately after crank release, while Low Oil Pressure and High Engine Temperature faults do not operate until the 'fault lock-out' time has expired (15 seconds after crank release).

The Auxiliary fault input may be triggered at any time. If the engine is starting or running at the time of an auxiliary fault, the AS3000 will shut down the engine; if the engine is stationary, starting is inhibited.

In the event of a shutdown fault, the operator should:-

- Make a note of the indicated fault LEDs
- To reset the fault, press the **OFF-STOP/** key
- Investigate the cause of fault.

The AS3000 should not be returned to Auto or Manual modes until the cause of shutdown has been found and corrected.



### Warning Only faults

A lit **CHARGE FAIL/** LED indicates a battery/DC charging fault. Two inputs allow for the monitoring of an engine driven charge alternator (pin 6) and/or an AC powered battery charger (pin 11). For further operating details, please refer to 'electrical connection' above.

Following a charge fail fault, the AS3000 does not shut down the engine, but does activate its Common Alarm outputs. The charge fail fault is non-latching: the charge fail LED goes out and the Common Alarm outputs de-activate as soon as the fault clears.

### Speed signal fault

Once the fault lockout time has expired, and provided magnetic pickup or generator AC speed measurement has been set, the AS3000 will continually check that an engine speed signal is present.

If the speed signal fails when the engine is running, both **START FAIL/** and **OVERSPEED/** LEDs will flash. Use link 9 on the AS3000P circuit board to set whether this fault results in a 'shutdown' or 'warning only' response.

Product Discontinued  
Check for Availability



**FW Murphy**  
PO Box 470248  
Tulsa, Oklahoma 74147, USA  
**tel:** +1 918 317 4100  
**fax:** +1 918 317 4266  
**email:** sales@fwmurphy.com  
**web:** www.fwmurphy.com

**CONTROL SYSTEMS & SERVICES DIVISION**  
PO Box 1819, Rosenberg, Texas 77471, USA  
**tel:** +1 281 633 4500  
**fax:** +1 281 633 4588  
**email:** sales@fwmurphy.com

**MURPHY DE MEXICO S.A. DE C.V.**  
Blvd. Antonio Rocha Cordero 300, Fracción del  
Aguaje San Luis Potosí, S.L.P. México 78384  
**tel:** +52 444 8206264  
**fax:** +52 444 8206336  
**Villahermosa office tel:** +52 993 3162117  
**email:** ventasmex@murphymex.com.mx  
**web:** www.murphymex.com.mx

**INDUSTRIAL PANEL DIVISION**  
PO Box 470248  
Tulsa, Oklahoma 74147, USA  
**tel:** +1 918 317 4100  
**fax:** +1 918 317 4266  
**email:** sales@fwmurphy.com  
**web:** www.fwmurphy.com

**FRANK W. MURPHY LTD.**  
Church Rd, Laverstock, Salisbury, SP1 1QZ, UK  
**tel:** +44 1722 410055  
**fax:** +44 1722 410088  
**email:** sales@fwmurphy.co.uk  
**web:** www.fwmurphy.co.uk



*In order to consistently bring you the highest quality, full featured products, we reserve the right to change our specifications and designs at any time.*