

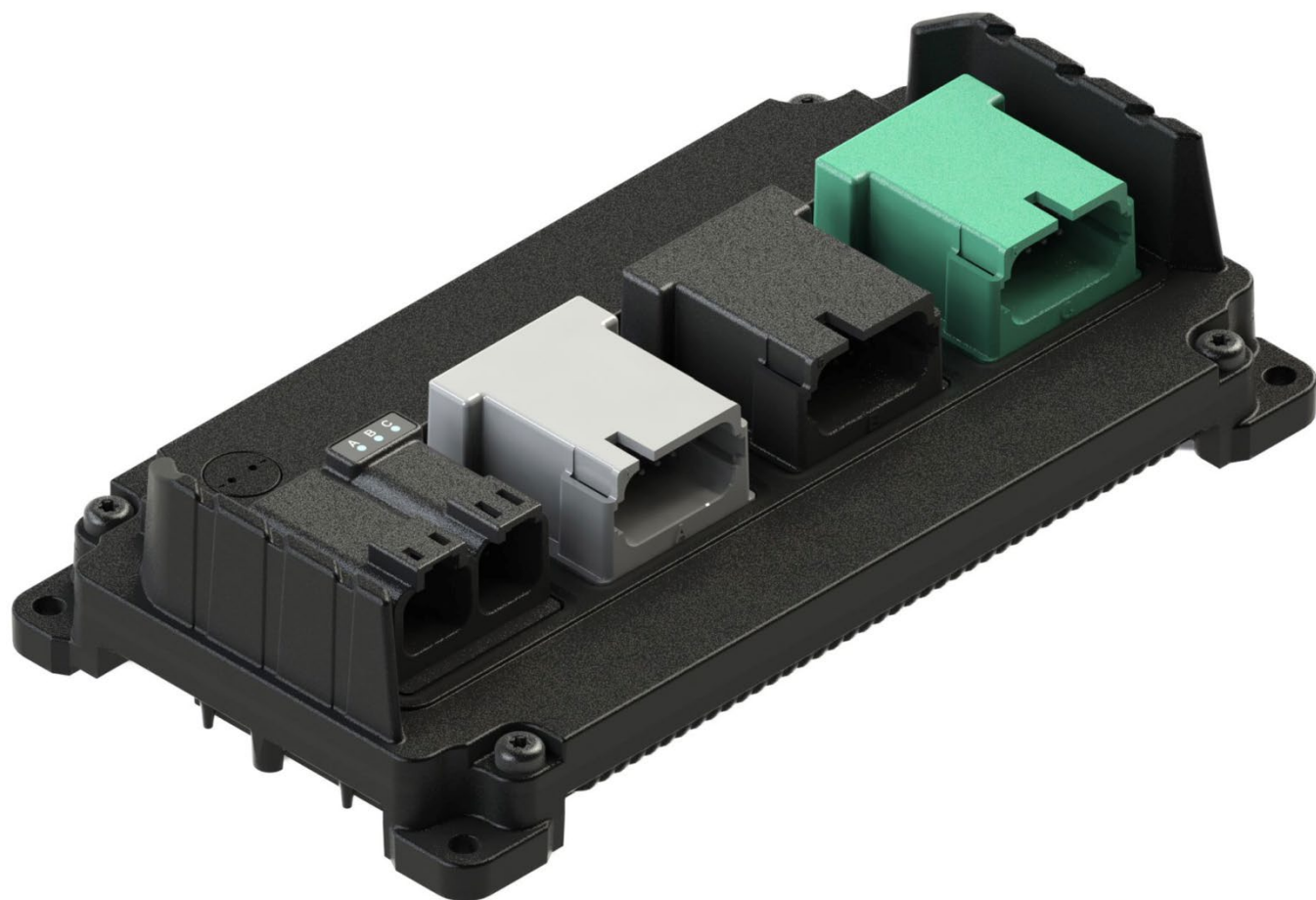

by *ENOVATION* CONTROLS



uControl™ Modular Control Series Technical Reference Manual

In order to consistently bring you the highest quality, full featured products, we reserve the right to change our specifications and designs at any time. The latest version of this manual can be found at www.enovationcontrols.com.

Warranty – a limited warranty on materials and workmanship is given with this Enovation Controls product. A copy of the warranty may be viewed by going to <https://www.enovationcontrols.com/warranty>.



Please read the following information before installing.

BEFORE BEGINNING INSTALLATION OF THIS ENOVATION CONTROLS PRODUCT:

Read and follow all installation instructions.

Please contact Enovation Controls immediately if you have any questions.

Note: This manual was written with great care and precision. However, since the potential for error exists, we can provide no assurance of the absolute accuracy of its contents.

DISCLAIMER OF WARRANTIES AND LIMITATION OF LIABILITY

The information, recommendations, and descriptions in this document are based on Enovation Control's experience and does not cover all contingencies. If further information is required, please contact Enovation Controls.

THERE ARE NO UNDERSTANDINGS, AGREEMENTS, WARRANTIES, EXPRESSED OR IMPLIED, INCLUDING WARRANTIES OF FITNESS FOR A PARTICULAR PURPOSE.

In no event will Enovation Controls be responsible to the purchaser or user in contract, in tort (including negligence), strict liability or otherwise for any special, indirect, incidental or consequential damage or loss whatsoever resulting from the use of the information, recommendations and descriptions contained in this document. The information contained in this technical documentation is subject to change without notice.

Contents

SAFETY CONSIDERATIONS	5
INTRODUCTION	5
KEY ACRONYMS AND ABBREVIATIONS	6
FEATURES	6
APPLICATION	7
HARDWARE DESCRIPTION	7
BLOCK DIAGRAM	12
SOFTWARE DESCRIPTION	13
SOFTWARE INSTALLATION.....	15
FUNCTIONALITY AND BASIC OPERATION.....	16
CONTROLLER STARTUP.....	16
SLEEP MODE (TIME DELAY OPERATION).....	17
TASK CONFIGURATION	18
WATCHDOG OPERATION.....	18
REMANENT VARIABLES.....	20
FILE SYSTEM OPERATION.....	21
LED OPERATION	22
INSTALLING THE CONTROLLER.....	22
PRODUCT DIMENSIONS	22
 RECOMMENDED WIRING PRACTICES	23
CONFIGURATION	24
SYSTEM CONFIGURATION	24
<i>System Config I/O Mapping.....</i>	<i>24</i>
<i>System Config Configuration.....</i>	<i>26</i>
INPUTS.....	27
<i>Inputs I/O Mapping.....</i>	<i>28</i>
<i>Inputs Configuration</i>	<i>29</i>
OUTPUTS.....	35
<i>Outputs I/O Mapping.....</i>	<i>37</i>
<i>Outputs Configuration</i>	<i>37</i>
<i>Shared Output (PWM) Fault Configuration</i>	<i>39</i>
FAULT TABLE	41
<i>Fault Table I/O Mapping</i>	<i>41</i>
<i>Status.....</i>	<i>42</i>
APPENDIX A – FAULT CONDITIONS	43
SYSTEM FAULTS	43
INPUT FAULTS.....	49
OUTPUT FAULTS.....	50
OUTPUT DRIVER FAULTS	51
<i>Output Driver to Channels/Pins Mapping</i>	<i>52</i>
APPENDIX B – INPUT CIRCUIT RESISTOR NETWORK.....	55

uControl Technical Reference Manual

BELOW IS A REPRESENTATION OF THE ANALOG INPUT CIRCUIT AND IT DEPICTS THE VARIOUS PULL-UPS AND PULL-DOWNS THAT ALLOW FOR VARIOUS DIFFERENT OPERATIONAL MODES REQUIRED FOR INTERFACING DIFFERENT INPUT DEVICES.	55
ANALOG INPUT CIRCUIT (PASSIVE REPRESENTATION)	55
BELOW IS A REPRESENTATION OF THE FREQUENCY INPUT CIRCUIT AND IT DEPICTS THE VARIOUS PULL-UPS AND PULL-DOWNS THAT ALLOW FOR VARIOUS DIFFERENT OPERATIONAL MODES REQUIRED FOR INTERFACING DIFFERENT INPUT DEVICES.	56
FREQUENCY INPUT CIRCUIT (PASSIVE REPRESENTATION)	56
APPENDIX C – DEEP DIVE: PWM AND DITHER.....	57
WHAT IS PWM?.....	57
WHAT IS DITHER?.....	57
PWM WAVEFORMS	58
<i>PWM Using No Dither</i>	58
<i>PWM Using Sinusoidal Dither</i>	59
<i>PWM Using Sinusoidal Dither (close-up)</i>	60
<i>PWM Using Square Wave Dither</i>	61
<i>PWM Using Square Wave Dither (close-up)</i>	62
APPENDIX D – DEVICE COMMUNICATION TROUBLESHOOTING	63
APPENDIX E – HARDWARE SPECIFICATIONS	65
1. FUNCTIONAL SPECIFICATION.....	65
1.1 PHYSICAL & ENVIRONMENTAL	65
1.2 POWER SUPPLY	65
1.3 CPU	65
1.4 MEMORY	66
1.5 STANDARDS & TESTING (PENDING).....	66
1.6 CERTIFICATIONS (PENDING)	68
1.6.1 CE Mark	68
1.6.2 REACH / RoHS.....	68
1.6.3 e-Mark	68
1.7 CAN COMMUNICATIONS	68
1.8 SENSOR SUPPLY	68
1.9 INPUTS	69
1.9.1 Analog Function	69
1.9.3 Digital Functions.....	70
1.9.4 Sleep Function.....	70
1.10 OUTPUTS	71
1.10.1 Digital Output - 4A	71
1.10.2 Proportional PWM Output - 4A.....	71
1.10.3 Proportional PWM Output Dual Range - 4A / 0.4A.....	72
1.10.4 PWM Output – 15A Single, 25A in parallel mode.....	73
1.10.5 LED Indicators	74
2. PHYSICAL SPECIFICATION & VARIANTS.....	75
2.1 UCONTROL VARIANTS.....	75
2.2 SUMMARY OF I/O	75
2.3 CONNECTIONS.....	76
2.3.1 Mating Connector J1A – 4 Pin	76
2.3.2 Mating Connector J1B – 6 Pin	76
2.3.3 Mating Connector J1 – 18 Pin with E Key.....	76
2.3.4 Mating Connector J2 – 18 Pin with A Key	77
2.3.5 Mating Connector J3 – 18 Pin with B Key.....	77
2.3.6 Mating Connector J4 – 18 Pin with C Key.....	77

uControl Technical Reference Manual

2.3.7	<i>Mating Connector J4 – 18 Pin with D Key</i>	77
2.4	PINOUTS	78
2.4.1	<i>MC2-18-6 Pinout view with functions</i>	78
2.4.2	<i>MC3-21-10 Pinout view with functions</i>	79
2.4.3	<i>MC4-26-20 Pinout view with function</i>	80
2.4.4	<i>MC4-21-14-H8 Pinout view with functions</i>	81
2.5	MOUNTING DIAGRAMS	82

(THIS PAGE INTENTIONALLY LEFT BLANK)

Safety Considerations

Please note: These instructions are intended for use by a competent programmer, electrician, technician, or engineer, and should be read and kept as a reference prior to controller installation and use. Incorrect operation of the controller can present a significant threat to both individuals and equipment. In the event of a breakdown, do not attempt to repair the controller as there are no user serviceable parts inside the enclosure. Any evidence of tampering will invalidate the warranty.



Introduction

The robust mobile uControl series is a family of advanced CAN-based vehicular controllers specifically adapted to the needs of vehicle OEMs. Each unit in the series enables functional control over many different facets of a vehicle. They use one of three different programming environments: 1. ACE is an extremely user-friendly visual development environment that eliminates the need for skilled programmers; 2. CODESYS 3.5 is a standardized IEC 61131-3 programming environment with multiple language options suited for many with industrial experience; 3. C-API is a C language Application Programming Interface for advanced programmers and engineers. The unit is intended for operation in the most adverse environments encountered in mobile applications and is designed for direct mounting on the vehicle.

It is recommended that an individual have experience with control engineering and significant familiarity with the vehicle application prior to use of these controllers. The controllers feature I/O with a variable configuration architecture that is simple to manage. The unit also employs several advanced technologies designed to enhance the ease of use and functionality. It is intended both as a standalone controller for mobile application or as a centerpiece component for a complete system which could include a display and other CAN based devices.

Key Acronyms and Abbreviations

Term	Description
ACE	Auto Coding Environment
API	Application Programming Interface
CAN	Controller Area Network
CODESYS	Controller Development System
FET	Field Effect Transistor
FW	Firmware
HB	H-Bridge used for motor control
HW	Hardware
IDE	Integrated Development Environment
IP	Intellectual Property
LC	Low current profile
LED	Light Emitting Diode
MOSFET	Metal-Oxide-Semiconductor Field-Effect Transistor
MRAM	Magnetoresistive Random Access Memory
PCB	Printed Circuit Board
PM	Parallel mode used to couple two outputs together for greater drive current
POU	Program Organization Unit
PP	Push-Pull operation
PWM	Pulse Width Modulation
RAM	Random Access Memory
RTS	Run Time System
SSR	Solid State Relay
SW	Software
VBat	Battery Power
VDS	Voltage between MOSFET Drain and Source
VLoad	Load Power

Features

Feature	Controller			
	MC2-18-6	MC3-21-10	MC4-26-20	MC4-21-14-H8
Robust, compact, fully sealed & potted Cast Aluminum Construction	√	√	√	√
Virtual fuse technology	√	√	√	√
Completely protected outputs (thermal and overcurrent)	√	√	√	√
Reverse polarity protection	√	√	√	√

Total inputs	18	21	26	21
Total outputs	6	10	20	22
Diagnostic feedback for short-circuit & wire break on all outputs	√	√	√	√
Proven Deutsch connectors	√	√	√	√
Programmable via CAN	√	√	√	√

Feature	Controller			
	MC2-18-6	MC3-21-10	MC4-26-20	MC4-21-14-H8
CAN ports	2	3	3	3
Sleep/Wake input used in Low Power Consumption mode for improved power management	√	√	√	√
Regulated supply for sensors (400 mA)	1	1	2	2
Three LED status indicators (2 programmable)	√	√	√	√

Application

Using this operating manual in conjunction with the ACE development environment, similar documentation from 3S on the CODESYS 3.5 programming software package, or our C-API documentation forms a basis for the straightforward configuration of the controller and the creation of programs specific to your application needs.

The correct operation and functioning of the controller are dependent on the application instructions that are created and downloaded to the unit. We recommend extensive testing of the application on the controller both in a bench environment and in the expected operating environment. The OEM installing and creating the application for the controller is ultimately responsible of ensuring that the controller performs as intended. Please note that the controller requires the appropriate firmware to be loaded and that a hardware-specific device description file and libraries may also need to be installed in the application development environment.

Hardware Description

Each of the controllers is designed to function over an extended operating range of 6 – 32 VDC supply with nominal operation @ 12 or 24 VDC.

The integrated CAN ports support CAN2.0A & B. Depending on the application development environment chosen, CAN Layer 2, SAE J1939, and CANopen are possible options. The first CAN port is also used for programming.

The regulated output(s) can be configured individually for 5 or 10V operation and have up to 400 mA current capability each.

There are 4 controller models that comprise the family and each has a unique combination of I/O. The units all share a common microcontroller and memory architecture.

Hardware Memory:

Superscalar 32 Bit processor 200 MHz

The memory is arranged into the following areas:

- ROM Flash 3.75 Mbyte (1.75 Mbyte reserved for IEC application)
- EEPROM 128 kB reserved for internal use
- RAM 256 kB
- MRAM 32 kB (24 kB user accessible file system (note that this is also used by the persistent variables) + 4kB redundant retained memory)

The MC4-21-14-H8 incorporates 22 outputs comprised of:

- 8 x 15 A channels
- 8 x 4 A / 0.5 A dual range channels
- 6 x 4 A channels

The MC4-26-20 incorporates 20 outputs comprised of:

- 10 x 4 A / 0.5 A dual range channels
- 10 x 4 A channels

The MC3-21-10 incorporates 10 outputs comprised of:

- 4 x 4 A / 0.5 A dual range channels
- 6 x 4 A channels

The MC2-18-6 incorporates 6 outputs comprised of:

- 4 x 4 A / 0.5 A dual range channels
- 2 x 4 A channels

Each output channel is capable of:

- High Side operation
- Low Side operation
- Open loop PWM operation
- Closed loop PWM with current control

- Constant power mode – this digital mode is designed to work in conjunction with active loads that may draw very high currents when initially energized (e.g. LED lights with integral electronics, power supplies, and DC to DC converters).
- Push Pull vs. Floating – In Push Pull mode the load is always pulled either high or low depending on the output state. In floating the load is pulled high when active as a high side output, low when active as a low side output and open when inactive
- Being paired (parallel operation) with another channel for additional current capability – sometimes this functionality is referenced as bridging or strapping.
- Being configured with another channel for use as an H-Bridge – common for directional motor control.

Additionally, the dual range outputs feature an option for lower current drive with higher precision.

The MC4-21-14-H8 incorporates 21 inputs comprised of:

- 8 Universal Analog / High frequency inputs
- 13 Universal Analog inputs

The MC4-26-20 incorporates 26 inputs comprised of:

- 10 Universal Analog / High frequency inputs
- 16 Universal Analog inputs

The MC3-21-10 incorporates 21 inputs comprised of:

- 8 Universal Analog / High frequency inputs
- 13 Universal Analog inputs

The MC2-18-6 incorporates 18 inputs comprised of:

- 4 Universal Analog / High frequency inputs
- 14 Universal Analog inputs

Each Universal Analog input is capable of:

- 0 – 5 V
- 0 – 36 V
- 0 – 20 mA

- Resistive (100 Ω – 100 k Ω) note there are two ranges depending on pull-up selected.
- Low side digital
- High side digital
- Frequency up to 100 Hz

Additionally, the inputs with high frequency capability have 2 separate selectable thresholds. The inputs can detect a 1 Hz to 50 kHz frequency signal using the low voltage threshold and a 1 Hz to 25 kHz signal using the high voltage threshold. Note that certain external circuits may be capable of driving the input at frequencies higher than 25 kHz if they can sink sufficient drive current.

All the units also integrate internal temperature measurements that can be used in the IEC application.

Block Diagram

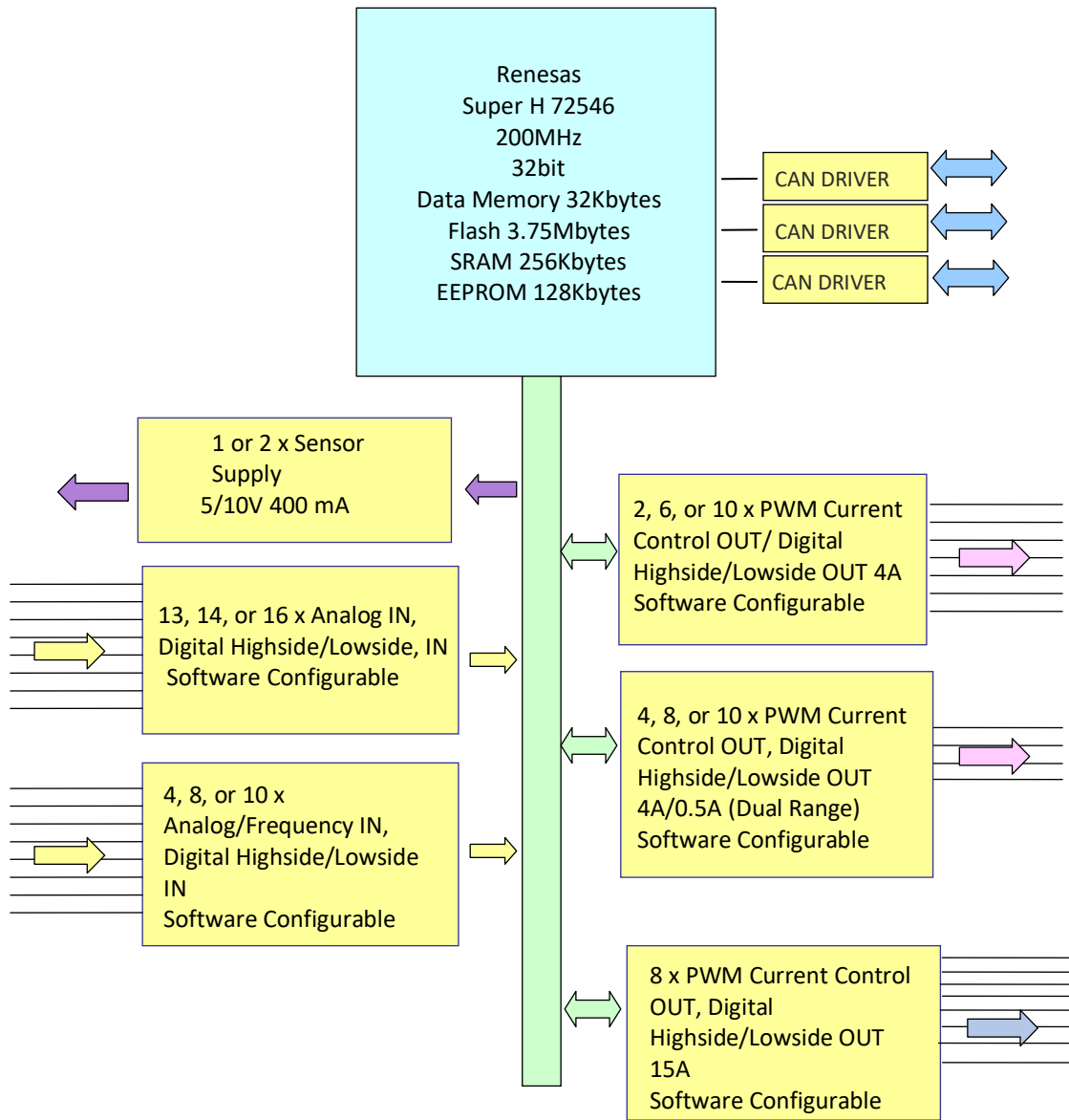

Software Description

The mobile controller includes firmware installed from the factory which consists of a variant-specific encrypted Motorola S-record file (.MOT file). Note: There are 4 variants (4 unique .MOT files) and a single file is used that is specific to the controller variant. Current firmware is version 1.1.28.

The controller also requires the following software:

- A service tool installer that assists field support personnel with troubleshooting, application download, and firmware update (e.g., EDIS display tool).
- A USB driver for the ECOM CAN to USB interface device.

The firmware can be updated (installed in the controller) using an ECOM USB to CAN dongle available from Enovation Controls. It is used in conjunction with the earlier mentioned firmware loading tool called EDIS. The password to reprogram a controller is “5ZIP-5UJ4-KD53-COTM”. Here is a screen shot of the program:

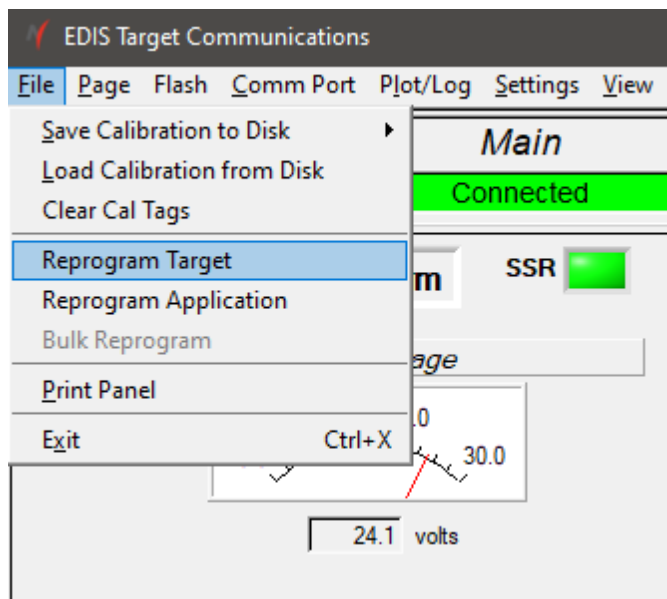

Please note that after selecting Reprogram Target, you will need to provide the directory path to the location of the specific .MOT file for your controller variant and then start the download.

Additional files are necessary to use the unit with the CODESYS IDE. These include:

- A CODESYS device descriptor XML file unique to the individual controller variant (e.g., MC4-26-20.devdesc.xml). This is required for setting up the controller in CODESYS and must be installed prior to attempting to program the unit using the IDE. Note the device descriptor file is version ending in .17.
- A PNG image file for the controller that is displayed in the IDE (e.g., MC4-26-20.png)

- A USB to RS232 interface dongle. Interface dongles are commonly available for \$10 to \$20 at merchants such as Amazon ([Link](#)).
 - The serial interface must be connected to the correct controller pins:
 - J2A2 (RS232 TX) connects to the dongle RS232 RX
 - J2A8 (RS232 RX) connects to the dongle RS232 TX, and
 - J2A13 (RS232 GND) connects to the dongle RS232 ground
- A CODESYS gateway .cfg file (see box below) for connecting to the controller via the serial port.
 - Paste the below into a new text file and save it as “gateway.cfg”.

Please note that the highlighted text as indicated below must be modified to reflect the actual name of the COM port your USB to RS232 interface dongle is connected to. Information on how to locate the name of your COM port is provided on the following page.

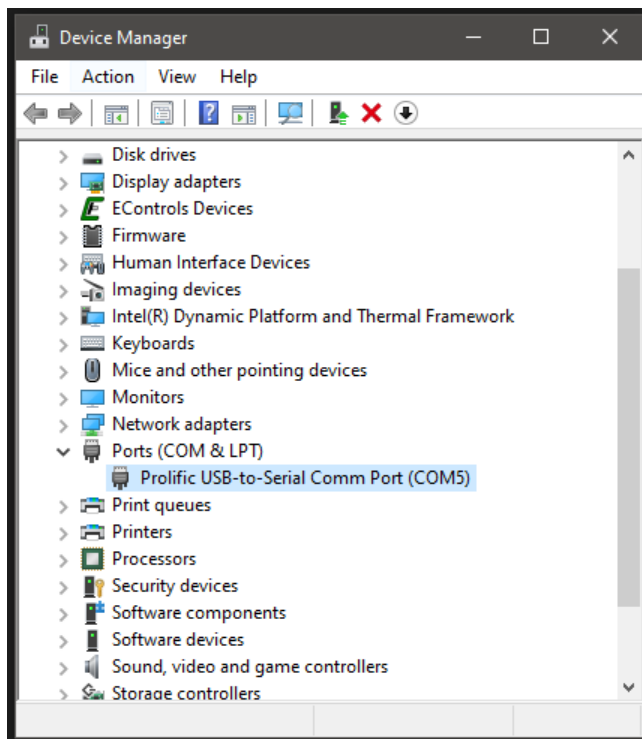

Software Installation

Step	Action
1	Install CODESYS
1.1	Install CODESYS V3.5 SP5 Patch 4(3.5.5.4) (CODESYS_3.5SP5_Release.zip) using all the default settings.
2	Install the CODESYS gateway file for the mobile controller
2.1	Copy the created gateway.cfg file over the one that exists at C:\Program Files (x86)\3S CODESYS\GatewayPLC. This file configures the serial port and baud rate that will be used by CODESYS when connecting to the mobile controller. Please note that this file will most likely need to be modified to include a reference to the specific serial port you are using on your computer.

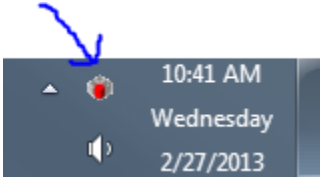
Step	Action
3	Restart gateway
3.1	<p>In order for the gateway changes to take effect, you must stop and restart the CODESYS gateway. This can be done by right-clicking on the gateway icon in your system tray bar next to the clock.</p> 
4	Install the target definition files for the mobile controller variants
4.1	Launch CODESYS and select Tools->Device Repository.
4.2	Click the "Install..." button.
4.3	Navigate to the directory containing the Device Descriptor and Highlight all of the contained ".devdesc.xml" files, then select open.
4.4	Click Close.
5	Create your first project
5.1	Click File->New Project.
5.2	Select "Standard Project". Provide a name for the project and Click "OK".

5.3	Select the appropriate Mobile Controller device and I/O count for the controller you will be using for your project. Click OK.
6	Connect and program your controller
6.1	Connect the mobile controller to your serial port via the 18 – pin Deutsch connector A: J2A2 (RS232 TX) connects to the dongle RS232 RX, J2A8 (RS232 RX) connects to the dongle RS232 TX and J2A13 (RS232 GND) connects to the dongle RS232 ground
6.2	Ensure that the unit is powered-up properly by verifying that LED A is illuminated.
6.3	In the CODESYS "Devices" tree view, double click on the "Device".
6.4	Click on the "Communication Settings" tab.
6.5	Click on the "Gateway-1" and then click "Scan Network".
6.6	One mobile controller device should appear. Click on it and select "Set active Path". If you have problems with this step, please see the troubleshooting steps in Appendix A.
6.7	Select "Online->Login" and then acknowledge any prompts that are displayed.
6.8	Click "Debug->Start".

Functionality and Basic Operation

Controller Startup

The IEC bootstrap provides a mechanism to:

- remove a frozen application
- load a new application
- reset origin (will clear entire application memory)
- Return to bootblock (clear firmware)

The IEC bootstrap sequence is as follows

1. Check for PWM 1 & 2 $\geq 11.0V$, apply $> 11 VDC$ to VBat. Note: If $> 11VDC$ is also applied to PWM 3, the unit will enter the bootblock and the firmware will need to be reloaded.
2. Delay 3 seconds
3. If ECIPP or IEC is connected, abort and don't load IEC app from flash
4. Otherwise, load and run the IEC app in Flash like normal

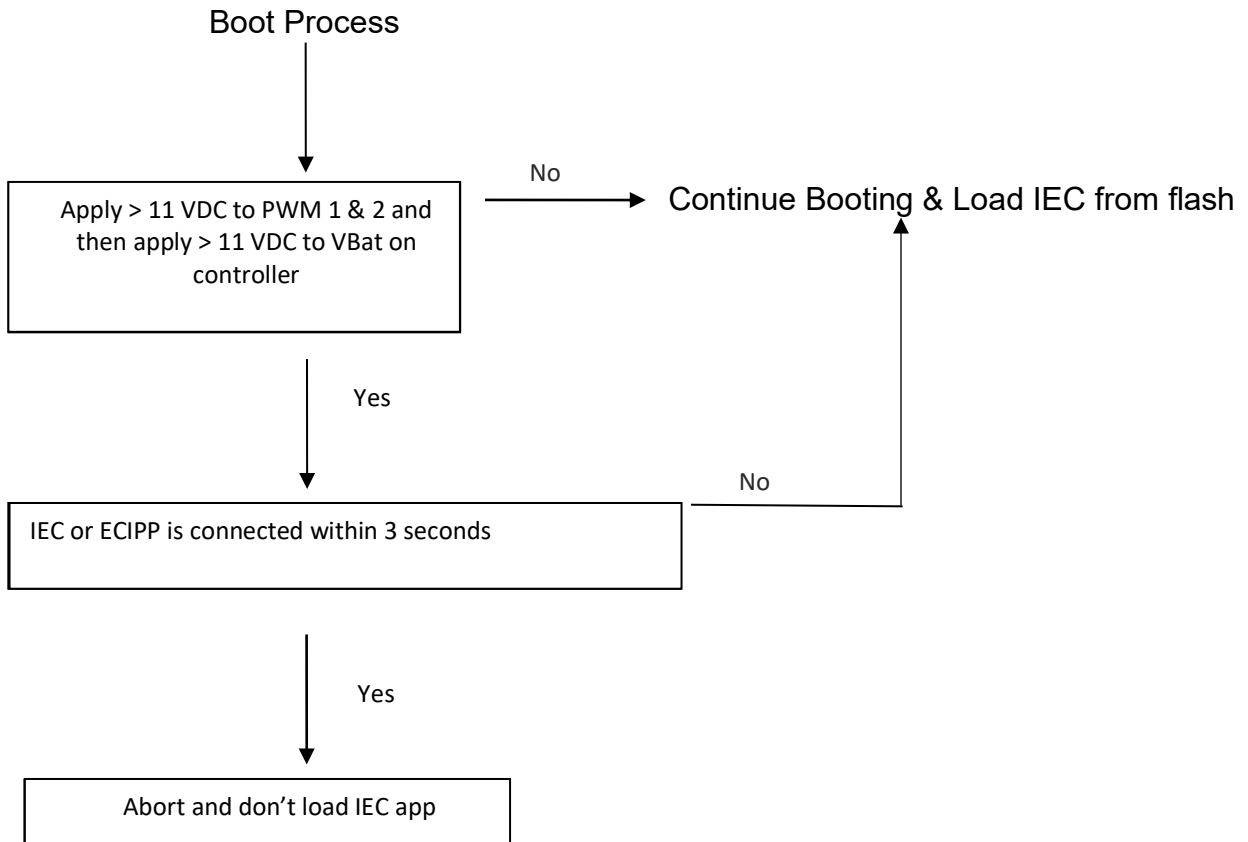

Please note that the RS232 connection required for the CODESYS IDE is shared with CAN 2. As a result, if you set up a CAN 2 connection in the application program, when it is downloaded the connection to the CODESYS IDE will be lost. It is recommended that during development of the project, the application includes a method to switch between CAN 2 and RS232 so that future connections from the CODESYS IDE to the controller can be established. Also note that once the development is complete and ready for production release the need to connect the CODESYS IDE should not be required so a method to switch to RS232 is not essential.

Sleep Mode (time delay operation)

The controller will enter Sleep Mode by setting the Sleep Bit anytime that the Sleep Allowed bit is true {Sleep pin is low}.

The controller will awaken from sleep if {Sleep is high or connected to power}.

Sleep current is nominally 5 mA @ 12V, 2.5 mA @ 24V. Note: measured at ambient temperature.

Task Configuration

The maximum number of tasks is 5. The controller supports the following types of tasks:

Cyclic: task processed within a predefined time interval.

Freewheeling: task processed as soon as the program is started. When it completes, it will automatically restart in a continuous loop.

Watchdog operation

The controller has three watchdog operations:

- an internal hardware watchdog (invisible to the user)
- a watchdog that monitors the CODESYS runtime system with a default value of 2 seconds. It is recommended that the minimum value for the watchdog value should not be less than 100 ms. The watchdog timeout is user-configurable via the System Config Configuration tab – see the screen below:

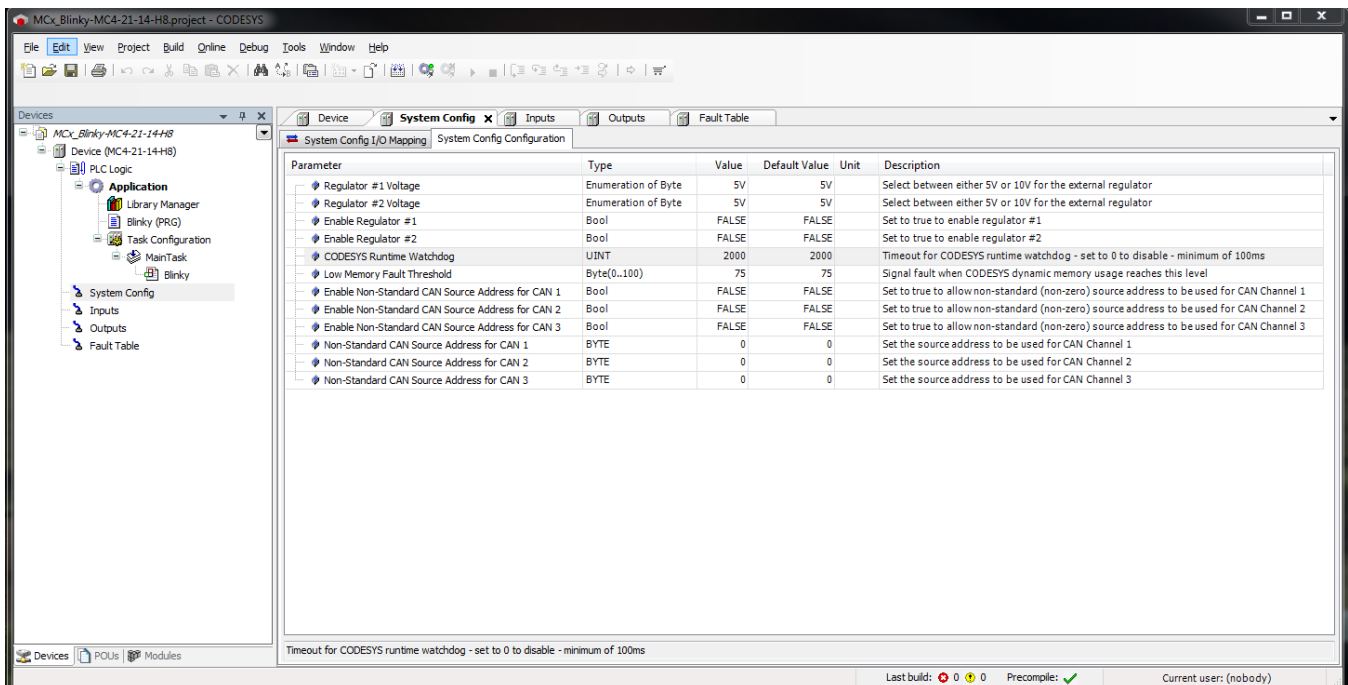

- a watchdog that monitors the specific task. The time is user configurable via the Task Configuration/MainTask tab – see the screen below:

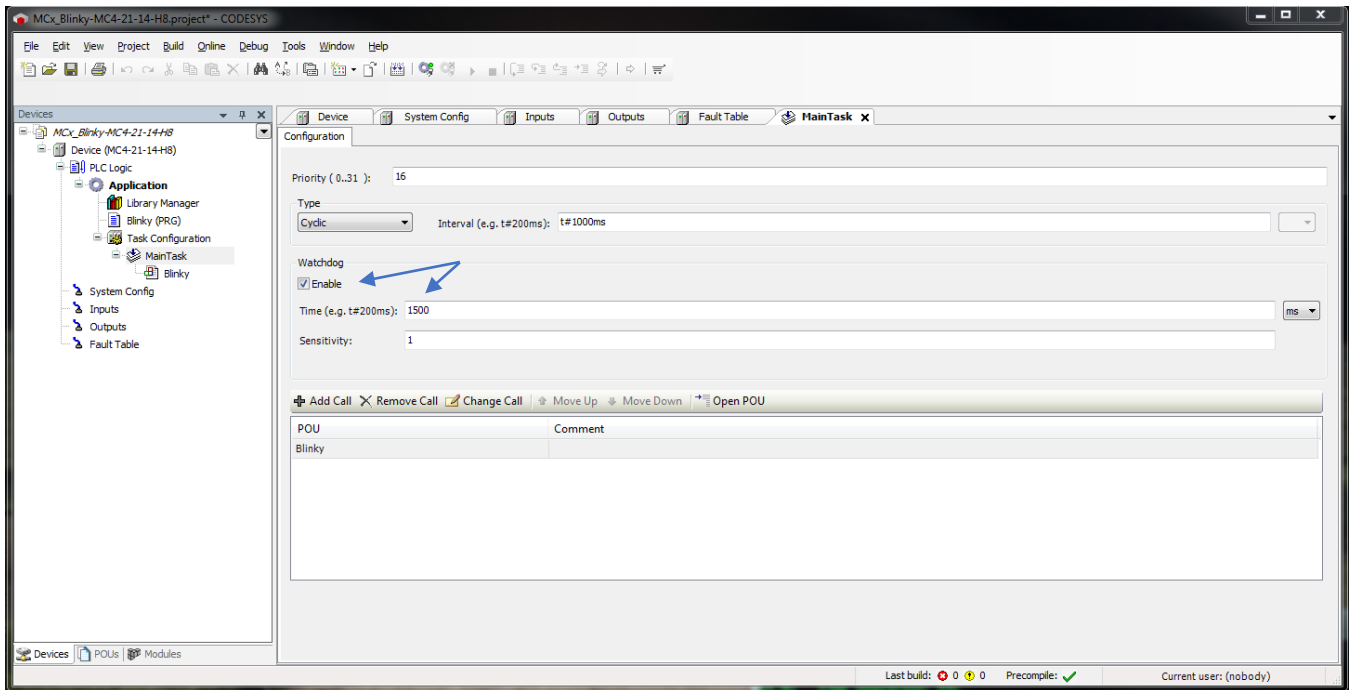

Remanent Variables

These are variables that can retain their value throughout the usual program run period. They are declared as 'Retain Variables' or more stringently as 'Persistent Variables'. For each case a separate memory area is used.

The declaration determines the degree of "resistance" of a remanent variable in the case of resets, downloads or a reboot of the PLC. In most applications both types of remanent variable will be used.

Note: in the table below that an X indicates the degree of remanence for each of the online actions, e.g., VAR is not retained after any of the actions while VAR RETAIN is only retained after a warm reset.

After Online command	VAR	VAR RETAIN	VAR PERSISTENT / VAR RETAIN PERSISTENT / VAR PERSISTENT RETAIN
Reset warm <application>	-	x	x
Reset cold <application>	-	-	x
Reset origin <application>	-	-	-
Download <application>		-	x

File System Operation

Often it is desirable to store additional auxiliary information such as configuration files, license files for libraries, calibration, hardware or software details, options, etc. on the device. The controller firmware provides the ability to logically organize this data into multiple files by integrating with the CODESYS SysFile library. We have chosen to use MRAM for this purpose because it:



- is much faster than Flash or EEPROM
- has unlimited read and write cycles, and
- can be accessed at the byte level vs. the 4 kB page typical of Flash.

There are multiple advantages to the controller employing the SysFile library (i.e., SysFileOpen, SysFileRead, and SysFileWrite functions) for storing user defined application data:

- No extra library to manage
- No extra RAM wasted
- Full access to all spare/non-retain MRAM
- Easy method to upload and download files to support special configurations or settings
- Future flexibility with increases in memory
- Direct graphical interface for transferring files between PC and controller
- Programmable file access from the controller during runtime using a CODESYS system library. Maximum 16-character directory & file name.

LED Operation

LED A (left-most) - Power (Green)

		
Off = Not powered up or firmware is not loaded.	Solid On = Powered up and CODESYS/Application not running.	Flashing Fast (250ms on, 250ms off) = CODESYS/Application running.

LED B (middle) - User Programmable (Amber)

- User programmable via System Config I/O variable (userLED1State)

LED C (right-most) - User Programmable (Blue)

User programmable via System Config I/O variable (userLED2State)

Miscellaneous states

LED A, B, C on solid: occurs during programming.

LED A, B, C blink briefly: occurs at initial power up indicating the controller ran the bootblock.

LED A, B, C off: occurs during sleep.

MC4-21-14-H8 Connector D 8 LEDs – Output is actively driven (Green)

The individual LEDs on Connector D illuminate when the corresponding 15A output is driven in proportional or binary mode. Note: if an H-Bridge is configured the two associated output LEDs illuminate when either channel is driven proportionally or in binary mode.

If a major fault occurs on a channel (e.g., low voltage or overcurrent), the LED associated with that channel will blink at a 5 Hz rate.

Installing the Controller

Product Dimensions

The controller is ideally mounted on a vertical flat surface with connectors facing down. Alternately, mounting the controller on a flat surface requires the harness to have a “drip loop” to prevent water from wicking through the wires into the connector.

Use four standard threaded fasteners to secure the controller to the surface (either 6 mm grade 8.8 or ¼” grade 5 diameter are acceptable).

Please see section 3.5 for specific dimensional data.



This section contains information about the controller connectors and pin outs. Please use the following recommended wiring practices when installing and using the controller:

- Ensure correct and adequate single point ground to prevent ground loops.
- Use twisted or twisted shielded pair cable for CAN per the applicable standard.
- Confirm that the CAN network is properly terminated using 120Ω resistors.
- Ensure the appropriately sized conductor cross section is specified for the intended load current in the harness design.

NOTE: Please review individual overcurrent shutdown values in the configuration and use the correct wire gauge conductor to accommodate the maximum load current configured.

- Make sure that voltage drops are kept within reasonable levels under maximum continuous load conditions, e.g., 1 volt on 12-volt systems and 2 volts on 24-volt systems.
- Verify that the harness is constructed to meet the needs of the application environment, e.g., shock, vibration, moisture, temperature, chemicals, and impact.
- Make certain that the harness is designed and constructed to minimize induced interference resulting from EMI coupling between signal wires.
- Separate power circuits from low-level signals.
- All splices (soldered or crimped) should use adhesive lined heat shrink tubing.
- Make provisions for drip loops to attach devices in exposed locations and prevent moisture entry and formation.
- Provide sufficient clearance from moving parts.
- Wires routed through holes in the vehicle body/chassis should use grommets.
- Avoid sharp metal edges, fasteners, and other abrasive surfaces or use protective shielding when routing harness assembly.
- Route wires to avoid exhaust system components or other high temperature areas, and use appropriate heat shielding or other insulation where routing is a problem.
- Avoid routing near wheel wells or provide adequate mechanical protection to the assembly.
- Use a protective fuse sized appropriately for the controller supply current. Note: typical maximum load current is 60% - 80% of fuse rating. Verify that wiring can handle more current than the fuse rating.
- Note: The controllers have outputs that are **not** intended to be connected directly to another device's outputs without isolation via diodes or relays!

Configuration

System Configuration

The System Configuration tab allows the configuration and monitoring of system level parameters and values.

System Config I/O Mapping

The controller features an advanced view into the hardware through the **System Config I/O Mapping** tab. There are numerous predefined variables associated with the controller that are accessible via the application program. This dramatically simplifies programming.

All these variables are pre-mapped with a relevant name linked with their respective channel. This name can be changed by the user if desirable. Each variable also has an associated address, type and description all intended to help the programmer.

The System Config I/O Mapping tab is organized into folders of related variables. For instance, the System State folder contains information such as Supply Voltage, Regulator Voltage, Sleep/Wake Pin Voltage, User LED State, Load Power Voltage, Internal Temperatures, etc. The other folders consist of a System Information folder - Firmware Rev, Serial Number, Hour Meter; a Solid State Relay folder – Relay State, Relay Current, etc.; a Global Fault Status folder for both active and historic faults; and a Fault Monitor folder for managing faults, etc. Please see the images below:

Variable	Mapping	Channel	Address	Type	Unit	Description
System State						
batteryVoltage		Battery Voltage	%IW0	Word		Variables that indicate system voltages and various other parameters The system or battery voltage
reg1Voltage		Regulator #1 Voltage	%IW1	Word		The voltage for sensor supply #1 (5V or 10V nominal) (pin J2-1)
reg2Voltage		Regulator #2 Voltage	%IW2	Word		The voltage for sensor supply #2 (5V or 10V nominal) (pin J4-1)
wakePinVoltage		Wake Pin Voltage	%IW3	Word		The WAKE pin voltage (pin P06)
sleepAllowed		Sleep Allowed	%IX8.0	BIT		Indicates whether hardware sleep is allowed (if the wake pin voltage is 0 (wake pin lo...
enterSleep		Enter Sleep	%QX0.0	BIT		When the "Sleep Allowed" indicator is TRUE, setting this bit high for one I/O cycle will...
bootReason		Bootup Reason	%IB9	Enum...		The source of the current boot (i.e. cold boot, reset, reprogram, sleep resume)
userLED1State		User LED 1 State	%QX0.1	BIT		Set to TRUE to turn on the user LED 1 (B)
userLED2State		User LED 2 State	%QX0.2	BIT		Set to TRUE to turn on the user LED 2 (C)
loadpwrVoltage		Load Power Voltage	%IW5	Word		The high-side driver LOAD_PWR+ (pre-Solid State Relay) input voltage
loadpwrProtected		Load Power Voltage (Protected)	%IW6	Word		The high-side driver LOAD_PWR+ protected (post-Solid State Relay) input voltage
topRailTemp		Top Heatrail Temp	%IW7	Int		Temperature measurement of the top heat rail
botRailTemp		Bottom Heatrail Temp	%IW8	Int		Temperature measurement of the bottom heat rail
dcSwitchTemp		DC Switch Temp	%IW62	Int		Temperature measurement at DC power switch
System Information						
Build/Firmware version, serial number, hour meter, and cumulative system start variabl...						
Solid State Relay						
View the status and control the state of the internal solid state relay						
Global Fault Status						
Variables to access and clear active and historic fault information						
Fault Monitor						
Provides detailed information for the fault assigned in the "Fault Index" variable						

uControl Technical Reference Manual

Variable	Mapping	Channel	Address	Type	Unit	Description
System State						Variables that indicate system voltages and various other parameters
System Information						Build/Firmware version, serial number, hour meter, and cumulative system start variabl...
buildMajorVersion		Build Major Version	%IB18	BYTE		Build major version of the firmware
buildMinorVersion		Build Minor Version	%IB19	BYTE		Build minor version of the firmware
buildPatchVersion		Build Patch Version	%IB20	BYTE		Build patch version of the firmware
firmwareMajorVersion		Firmware Major Version	%ID6	DWord		Firmware major version (XLS version)
firmwareMinorVersion		Firmware Minor Version	%ID7	DWord		Firmware minor version (SVN software revision)
firmwareIdentifier		Firmware Identifier	%ID8	DWord		Build date code for the current firmware
serialNumber		Serial Number	%ID9	DWord		The unique serial number of the controller
hourMeter		Hour Meter	%ID10	Real		Hour meter that tracks the time CODESYS is active and running
startCount		Cumulative Starts	%ID11	DWord		Counts the number of times that the system has been started
dynamicMemSize		Dynamic Memory Size	%IW24	UINT		Size of dynamic memory that is available to the CODESYS runtime
dynamicMemMaxUs...		Dynamic Memory Max Usage	%IW25	UINT		Maximum amount of dynamic memory used by the CODESYS runtime
Solid State Relay						View the status and control the state of the internal solid state relay
Global Fault Status						Variables to access and clear active and historic fault information
Fault Monitor						Provides detailed information for the fault assigned in the "Fault Index" variable

Variable	Mapping	Channel	Address	Type	Unit	Description
System State						Variables that indicate system voltages and various other parameters
System Information						Build/Firmware version, serial number, hour meter, and cumulative system start variabl...
Solid State Relay						View the status and control the state of the internal solid state relay
Global Fault Status						Variables to access and clear active and historic fault information
clearActiveFaults		Clear Active Faults (rising edge)	%QX0.4	BIT		On the rising edge will clear active faults - must be held high for one I/O cycle
activeFaultsSet		Active Fault Available	%IX64.1	BIT		If TRUE then there is at least one active fault latched in the system
activeFaultCount		Active Fault Count	%IW33	UINT		The number of active faults - the "Active Fault IDs" array contains which individual faul...
		Active Fault IDs	%IW34	ARRAY...		Each element contains an active fault ID - filled up to "Active Fault Count" with unuse...
clearHistoricFaults		Clear Historic Faults (rising edge)	%QX0.5	BIT		On the rising edge will clear all historic faults - must be held high for one I/O cycle
historicFaultsSet		Historic Fault Available	%IX92.0	BIT		If TRUE then there is at least one historic fault latched in the system
historicFaultCount		Historic Fault Count	%IW47	UINT		The number of historic faults - look in "Historic Fault IDs" to see which individual faults...
		Historic Fault IDs	%IW48	ARRAY...		Each element contains a historic fault ID - filled up to "Historic Fault Count" with unuse...
totalFaultCount		Total Fault Count	%IW60	UINT		Total number of faults that are provided by the current system firmware
Fault Monitor						Provides detailed information for the fault assigned in the "Fault Index" variable

Variable	Mapping	Channel	Address	Type	Unit	Description
System State						Variables that indicate system voltages and various other parameters
System Information						Build/Firmware version, serial number, hour meter, and cumulative system start variabl...
Solid State Relay						View the status and control the state of the internal solid state relay
Global Fault Status						Variables to access and clear active and historic fault information
Fault Monitor						Provides detailed information for the fault assigned in the "Fault Index" variable
fltMonIndex		Fault Index	%QW1	UINT		The "Fault Index" that will be monitored - it will take one I/O cycle before all other faul...
fltMonIsEnabled		Fault Is Enabled	%IX12...	BIT		TRUE if the "Fault Index" is valid and if the respective fault is enabled
fltMonConditionPre...		Fault Condition Present	%IX12...	BIT		TRUE if the fault condition is currently present
fltMonActive		Fault Active Latched	%IX12...	BIT		TRUE if the "Fault Index" is latched as active - for certain faults this may not change i...
fltMonHistoric		Fault Historic Latched	%IX12...	BIT		TRUE if the fault has occurred since the last time historic faults were cleared
fltMonCurrentStart		Current start cycle	%IX12...	BIT		TRUE if the historic fault has been active during the current start cycle
fltMonActiveStarts		Starts since active	%IB123	BYTE		Number of starts since last time the fault was active
fltMonClearActive		Clear Active (rising edge)	%QX4.0	BIT		On rising edge will clear the "Monitoring Fault ID" active latched status - must be held...
fltMonClearHistoric		Clear Historic (rising edge)	%QX4.1	BIT		On rising edge will clear the "Monitoring Fault ID" historic fault status - must be held hi...

System Config Configuration

The **System Config Configuration** tab enables the user to configure settings for Regulator Voltage, Watchdog Time, Low Memory Fault threshold and CAN Source Address definition. Please see below.

Parameter	Type	Value	Default Value	Unit	Description
Regulator #1 Voltage	Enumeration of Byte	5V	5V		Select between either 5V or 10V for the external regulator
Regulator #2 Voltage	Enumeration of Byte	5V	5V		Select between either 5V or 10V for the external regulator
Enable Regulator #1	Bool	FALSE	FALSE		Set to true to enable regulator #1
Enable Regulator #2	Bool	FALSE	FALSE		Set to true to enable regulator #2
CODESYS Runtime Watchdog	UINT	2000	2000		Timeout for CODESYS runtime watchdog - set to 0 to disable - minimum of 100ms
Low Memory Fault Threshold	Byte(0..100)	75	75		Signal fault when CODESYS dynamic memory usage reaches this level
Enable Non-Standard CAN Source Address for CAN 1	Bool	FALSE	FALSE		Set to true to allow non-standard (non-zero) source address to be used for CAN Channel 1
Enable Non-Standard CAN Source Address for CAN 2	Bool	FALSE	FALSE		Set to true to allow non-standard (non-zero) source address to be used for CAN Channel 2
Enable Non-Standard CAN Source Address for CAN 3	Bool	FALSE	FALSE		Set to true to allow non-standard (non-zero) source address to be used for CAN Channel 3
Non-Standard CAN Source Address for CAN 1	BYTE	0	0		Set the source address to be used for CAN Channel 1
Non-Standard CAN Source Address for CAN 2	BYTE	0	0		Set the source address to be used for CAN Channel 2
Non-Standard CAN Source Address for CAN 3	BYTE	0	0		Set the source address to be used for CAN Channel 3

Inputs

The controller has up to 26 multi-function inputs available for use depending on the model. The inputs are of two specific types:

- Configurable Analog/digital inputs
- Configurable Analog/digital inputs that support high frequency signals

These different configurations are possible through selection of the appropriate mode on the Inputs Configuration tab in the IDE. Please see the sections and screens below.

Truth table for default internal input resistor settings							
		X = default on mode change then user configurable D = always disabled E = always enabled blank = user configurable * = value is computed and compensates for any variation in the sensor supply pd = pull-down					
Input Mode	Weak pull-up	Strong pull-up	System pull-up	System Pull-down	Shunt	Pull-down (Term.)	Attenuator (DIV 7.8)
	22.1kΩ (5V)	1kΩ (5V)	2.4kΩ (VBat)	2.4kΩ	200Ω pd	10kΩ	10.6kΩ pd
Analog							
0 -20 mA					E		
0 - 5 VDC absolute					D	X	
0-5 VDC ratiometric*					D	X	
0 - 36 VDC					D	X	E
Resistive raw	X				D		
Resistive Table 1	X				D		
Resistive Table 2		X			D		
Digital							
Digital					D		X
Digital (low freq)					D		X
Pulse (Frequency)							
Pulse (T1 5V)					D	X	
Pulse (T2 VBat)			X		D		E

Inputs I/O Mapping

Below is the **Inputs I/O Mapping** tab. Up to 26 inputs can be configured as either Analog or Digital. Up to 10 inputs can be configured as high-speed pulse (frequency) inputs. The channels on this tab can be expanded to show the predefined measurements associated with the input. The channel's Analog Value is displayed in actual engineering units depending on the configured mode (Voltage – mV, Current – μ A, Resistance - Ω , or Temperature $^{\circ}$ C).

The channel values include measurements of Analog Value, Digital Value, Frequency, Duty Cycle, Phase Angle, Pulse Count, Up/Down Count, High Precision Frequency, and Frequency Edge Timestamp. If the channel is not high-speed frequency capable (Digital Low Frequency only), there will be no Duty Cycle, Phase Angle, or Up/Down Count.

Variable	Mapping	Channel	Address	Type	Unit	Description
InputA04		Input A04	%ID132			Input A04 values (high speed frequency capable)
InputA05		Input A05	%ID140			Input A05 values (high speed frequency capable)
InputA07		Input A07	%ID148			Input A07 values (high speed frequency capable)
InputA10		Input A10	%ID156			Input A10 values (high speed frequency capable)
InputA11		Input A11	%ID164			Input A11 values (high speed frequency capable)
InputA12		Input A12	%ID172			Input A12 values (high speed frequency capable)
InputB07		Input B07	%ID180			Input B07 values (high speed frequency capable)
InputB08		Input B08	%ID188			Input B08 values (high speed frequency capable)
InputB09		Input B09	%ID196			Input B09 values (high speed frequency capable)
InputB10		Input B10	%ID204			Input B10 values (high speed frequency capable)
InputA06		Input A06	%ID212			Input A06 values
InputA14		Input A14	%ID217			Input A14 values
InputA15		Input A15	%ID222			Input A15 values
InputA16		Input A16	%ID227			Input A16 values
InputA17		Input A17	%ID232			Input A17 values
InputA18		Input A18	%ID237			Input A18 values
InputB01		Input B01	%ID242			Input B01 values
InputB11		Input B11	%ID247			Input B11 values
InputB12		Input B12	%ID252			Input B12 values
InputB13		Input B13	%ID257			Input B13 values
InputC07		Input C07	%ID262			Input C07 values
InputC08		Input C08	%ID267			Input C08 values
InputC09		Input C09	%ID272			Input C09 values
InputC10		Input C10	%ID277			Input C10 values
InputC11		Input C11	%ID282			Input C11 values
InputC12		Input C12	%ID287			Input C12 values

Variable	Mapping	Channel	Address	Type	Unit	Description
InputA04		Input A04	%ID132			Input A04 values (high speed frequency capable)
analogValueA04		Analog value	%ID132	Real	mV uA Ω °C	Analog value with units dependent on the configured mode
digitalValueA04		Digital value	%IX532.0	Bool		Digital value after debounce, rising/falling voltage thresholds, and digital logic are applied
frequencyA04		Frequency	%IW267	Word	Hz	Measured frequency of the input waveform
dutyCycleA04		Duty cycle	%ID134	Real	%	Measured duty cycle of the input waveform
phaseAngleA04		Phase angle	%ID135	Real	deg	Phase angle relative to channel pair defined in configuration
pulseCountA04		Pulse count	%ID136	DWord	pulses	Rolling pulse counter
upDownCountA04		Up/Down count	%ID137	DInt		Encoder up/down count value
freqHPA04		Frequency (high precision)	%ID138	Real	Hz	Measured fractional frequency of the input waveform
freqTSA04		Frequency edge timestamp	%ID139	Real	ms	Timestamp of the last edge detection
InputA05		Input A05	%ID140			Input A05 values (high speed frequency capable)
InputA07		Input A07	%ID148			Input A07 values (high speed frequency capable)

Inputs Configuration

Below is the **Inputs Configuration** tab. The programmer changes the configuration of an individual input using the Input mode drop down selection. The options are as follows:

- 0-5 V mode (ratiometric):
 - 10 kΩ pull-down defaulted On but configurable
 - Shunt is disabled
 - All other pull-ups and pull-downs are defaulted Off but user-configurable
- 0-5 V mode (absolute):
 - 10 kΩ pull-down defaulted On but configurable
 - Shunt is disabled
 - All other pull-ups and pull-downs are defaulted Off but user-configurable
- 0-36 V mode
 - 10 kΩ pull-down defaulted On but configurable
 - Attenuator is forced On
 - Shunt is disabled
 - All other pull-ups and pull-downs are defaulted Off but user-configurable
- 0-20 mA mode:
 - Shunt is forced On
 - All other pull-ups and pull-downs are defaulted Off but user-configurable
- Thermistor raw mode (provides the 10kΩ to 50kΩ value):
 - 22.1 kΩ pull-up defaulted On but configurable
 - Shunt is forced Off
 - All other pull-ups and pull-downs are defaulted Off but user-configurable
- Thermistor #1 mode (provides the temperature value):
 - 22.1 kΩ pull-up defaulted On but configurable
 - Shunt is forced Off

- All other pull-ups and pull-downs are defaulted Off but user-configurable
- Thermistor #2 mode (provides the temperature value):
 - 1 k Ω pull-up defaulted On but configurable
 - Shunt is forced Off
 - All other pull-ups and pull-downs are defaulted Off but user-configurable
- Digital:
 - Attenuator defaulted On but configurable
 - Shunt is forced Off
 - All other pull-ups and pull-downs are defaulted Off but user-configurable
- Digital low freq:
 - Attenuator defaulted On but configurable
 - Shunt is forced Off
 - All other pull-ups and pull-downs are defaulted Off but user-configurable
- Frequency/Pulse Thresh #1:
 - 10 k Ω pull down defaulted On
 - Shunt forced Off
 - All other pull-ups and pull-downs are defaulted Off but user-configurable
- Frequency/Pulse Thresh #2:
 - Attenuator is always On
 - Shunt is forced Off
 - 2.4 k Ω pull-up to supply voltage is defaulted On but user-configurable
 - All other pull-ups and pull-downs are defaulted Off but user-configurable

Please note that although the individual modes configure the pull-up and pull-down resistors as indicated above, the value fields displayed are not updated accordingly! Advanced users can set the Override resistor value to True and set the pull-up and pull-down resistors manually for esoteric applications; in this case the selected mode will be used to select engineering units only (mV, μ A, Ω , $^{\circ}$ C).

uControl Technical Reference Manual

Parameter	Type	Value	Default Value	Unit	Description
Input A04					Input A04 configuration (high speed frequency capable)
Input A05					Input A05 configuration (high speed frequency capable)
Input A07					Input A07 configuration (high speed frequency capable)
Input A10					Input A10 configuration (high speed frequency capable)
Input A11					Input A11 configuration (high speed frequency capable)
Input A12					Input A12 configuration (high speed frequency capable)
Input B07					Input B07 configuration (high speed frequency capable)
Input B08					Input B08 configuration (high speed frequency capable)
Input B09					Input B09 configuration (high speed frequency capable)
Input B10					Input B10 configuration (high speed frequency capable)
Input A06					Input A06 configuration
Input A14					Input A14 configuration
Input A15					Input A15 configuration
Input A16					Input A16 configuration
Input A17					Input A17 configuration
Input A18					Input A18 configuration
Input B01					Input B01 configuration
Input B11					Input B11 configuration
Input B12					Input B12 configuration
Input B13					Input B13 configuration
Input C07					Input C07 configuration
Input C08					Input C08 configuration
Input C09					Input C09 configuration
Input C10					Input C10 configuration
Input C11					Input C11 configuration
Input C12					Input C12 configuration
Thermistor #1 Lookup Table					Lookup table for thermistor #1. Resistances must be in increasing order
Thermistor #2 Lookup Table					Lookup table for thermistor #2. Resistances must be in increasing order

Parameter	Type	Value	Default Value	Unit	Description
Input A04					Input A04 configuration (high speed frequency capable)
Input mode	Enumeration of Byte	0 to 36V	0 to 36V		Input mode - determines configuration of resistor pull-up/downs and scaling
Override resistors	Bool	FALSE	FALSE		Enable or disable default resistor settings override
Pull-up enabled	Bool	FALSE	FALSE		Enable or disable the pull-up resistor to 5V (standard value is 22.1kΩ)
Strong Pull-up enabled	Bool	FALSE	FALSE		Enable or disable the strong pull-up resistor to 5V (standard value is 1kΩ)
Pull-down enabled	Bool	TRUE	TRUE		Enable or disable the pull-down to ground resistor (standard value is 10kΩ)
System pull-up/down enabled	Enumeration of Byte	None	None		Select to enable the pull-up to system power or system pull-down resistor (standard value is 2.375kΩ) or not
Attenuation enabled	Bool	TRUE	TRUE		Enable or disable the attenuation pull-down to ground resistor (standard value is 1.47kΩ)
Current shunt enabled	Bool	FALSE	FALSE		Enable or disable the current shunt resistor (standard value is 200Ω)
Filter time constant	Enumeration of Byte	Off	Off	ms	Low-pass filter time constant
Digital debounce	Byte(0..250)	50	50	ms	Digital input debounce period (only applies to "Digital Value" parameter)
Digital rising threshold	Word	2500	2500	mV	Rising voltage threshold for digital "high" value (only applies to "Digital Value" parameter)
Digital falling threshold	Word	1000	1000	mV	Falling voltage threshold for digital "low" value (only applies to "Digital Value" parameter)
Over-range limit	Real	36000	36000	mV uA Ω °C	Upper limit for this channel's over-range fault (units depends on selected mode)
Under-range limit	Real	0	0	mV uA Ω °C	Lower limit for this channel's under-range fault (units depends on selected mode)
Digital Logic	Enumeration of Byte	Active High	Active High		Select active high or active low for digital input value interpretation
Digital Circuitry	Enumeration of Byte	Present	Present		High speed digital circuitry presence indication (presence is required for frequency/pulse input mode)
System pull-up circuitry	Enumeration of Byte	Present	Present		Pull-up to system voltage circuitry presence indication
Frequency/Pulse Mode	Enumeration of Byte	Normal mode	Normal mode		Select normal mode or encoder mode for frequency/pulse input
Phase channel pair	Enumeration of UINT	None	None		Selects the channel pairing that will be used when calculating phase angle between two channels
Sensor Supply	Enumeration of Byte	Regulator #1	Regulator #1		Selects the sensor supply used as reference voltage if this input is ratiometric
Input A05					Input A05 configuration (high speed frequency capable)
Input A07					Input A07 configuration (high speed frequency capable)

Each of the analog modes offers a user-adjustable filter. The purpose of the filter is to smooth an input signal and/or limit how quickly it is changing. The filter is a digital approximation of a first order series RC network (low pass filter). The adjustable time constant is equivalent to the product of $R \cdot C$ in a conventional RC filter. The input should track the following curve approximately ($\pm 10\%$): 63% of the new step-response value after 1 time constant, after 2 time constants you will get to 86% and after 3 time constants you will get 98%.

The digital mode features adjustable rising and falling threshold levels. This is intended to offer additional flexibility for input device selection. There is also a debounce associated with each input. It is only intended for digital use (mainly to prevent inadvertent input triggering from multiple mechanical contact closures) and can be set to zero (0) if not needed. The debounce has a user-configurable time period. Each digital input can function with either low-side or high-side input types.

Between 4 and 10 inputs can be configured as high-speed Pulse (Frequency) inputs depending on the controller model. All inputs can be set to have the thresholds adjusted to one of two On/Off levels.

A duty cycle calculation is supported on these input channels. When measuring frequency, phase, pulse width or count, the measurement limit is the shortest detectable pulse (e.g., 20 μ sec).

When using inputs configured as Frequency/Pulse Mode Normal, voltage indication is not supported. The debounce filters are not intended for frequency inputs in general. When using channels 1 – 8 as frequency input, these are single ended inputs and trigger on one of two separate levels. The first level (Pulse Threshold 1) is On at approximately 2.5 volt rising and Off at approximately 1.25 volt falling. The second level (Pulse Threshold 2) is On at approximately 7.5 volt rising and Off at approximately 3.7 volt falling.

When using inputs configured as Frequency/Pulse Mode Encoder, a Phase Channel Pair can be selected to allow phase angle calculations and provide an appropriate interface for a rotary incremental encoder. This will allow the user to obtain up/down count, speed/frequency, position, and direction indication.

There is a fault that trips if the combined input frequency of all channels exceeds 200kHz. This does not stop operation; however, the fault is intended as a warning that you are exceeding the limits of what the hardware can measure.

NOTE: When any of the above channels are configured as digital (HS or LS) the sampling frequency is 1 kHz and supports a maximum signal frequency of 200 Hz. The debounce filters are intended for this mode.

Additionally, each of the modes offer a user-configurable under-range and over-range limit coupled to respective input faults (Input xx Value over-range/under-range).

NOTE 1: There is an overcurrent fault that triggers when the input exceeds approximately 23.5 mA for 25 ms in 0 – 20 mA mode.

NOTE 2: Ratiometric mode compensates for the measured regulated output voltage variance and normalizes the input value relative to 5 Volts.

NOTE 3: Thermistor #1 & #2 modes display a value based on two user-configurable lookup tables, see below:

Parameter	Type	Value	Default Value	Unit	Description
Thermistor #1 Lookup Table					Lookup table for thermistor #1. Resistances must be in increasing order
Resistance Point #1	Real	101	101		Smallest resistance value
Temperature Point #1	Real	242.4	242.4		
Resistance Point #2	Real	121	121		
Temperature Point #2	Real	231.9	231.9		
Resistance Point #3	Real	175	175		
Temperature Point #3	Real	211.6	211.6		
Resistance Point #4	Real	209	209		
Temperature Point #4	Real	201.4	201.4		
Resistance Point #5	Real	302	302		
Temperature Point #5	Real	181.9	181.9		
Resistance Point #6	Real	434	434		
Temperature Point #6	Real	163.1	163.1		
Resistance Point #7	Real	625	625		
Temperature Point #7	Real	144.9	144.9		
Resistance Point #8	Real	901	901		
Temperature Point #8	Real	127.4	127.4		
Resistance Point #9	Real	1556	1556		
Temperature Point #9	Real	102.4	102.4		
Resistance Point #10	Real	2689	2689		
Temperature Point #10	Real	78.9	78.9		
Resistance Point #11	Real	5576	5576		
Temperature Point #11	Real	49.9	49.9		
Resistance Point #12	Real	11562	11562		
Temperature Point #12	Real	23.5	23.5		
Resistance Point #13	Real	28770	28770		
Temperature Point #13	Real	-5.7	-5.7		
Resistance Point #14	Real	49715	49715		
Temperature Point #14	Real	-21.2	-21.2		
Resistance Point #15	Real	71589	71589		
Temperature Point #15	Real	-30.8	-30.8		
Resistance Point #16	Real	99301	99301		Largest resistance value
Temperature Point #16	Real	-40.0	-40.0		
Thermistor #2 Lookup Table					Lookup table for thermistor #2. Resistances must be in increasing order

We use 22kΩ pullup resistors in this mode (thermistor 1) and therefore recommend that you use resistances in the range of 500Ω and 100kΩ for optimal performance. Additionally, a second resistive mode can be used (thermistor 2). We use a 1kΩ pullup resistor in this mode and this is best selected when resistances range between 10Ω and 500Ω.

Thermistor example of actual readings per channel

Input Channel	0ohm	100ohm	1kohm	10kohm	20khom	50kohm
1	10.8	113.8	1010.9	10088.8	20350.0	52347.0
2	10.2	108.5	1007.0	10089.2	20350.0	52438.0
3	6.8	108.5	1005.2	10089.2	20350.0	52418.0
4	8.8	108.5	1005.0	10074.8	20330.0	52436.0
5	5.4	108.3	1005.0	10066.0	20309.7	52283.0
6	10.8	108.5	1005.0	10066.0	20309.7	52346.0
7	0	103.0	999.1	10043.0	20269.8	52210.0
8	0	103.0	999.1	10031.3	20239.8	52094.0
9	0	99.5	993.2	10019.8	20228.7	52068.0
10	5.4	108.5	1005.0	10066.0	20309.7	52336.0
11	0	98.6	993.2	10006.0	20188.3	51969.0
12	0	102.5	999.1	10054.5	20289.4	52220.0
13	5.8	108.5	1005.0	10054.5	20289.4	52283.0
14	5.4	105.8	1005.0	10066.0	20309.7	52283.0
15	6.8	108.5	1005.0	10077.6	20330.0	52400.0
16	6.4	108.5	1005.0	10077.8	20331.0	52408.0

Outputs

The controller offers between 6 and 22 outputs depending on the model. The outputs are all configurable as Off, Digital (On/Off), PWM, and PWMi (PWM Closed Loop Current Control). In addition to these modes, the outputs can be configured with one of three drive profiles consisting of: Single Channel Operation, H-Bridge Operation, and Parallel Channel Operation (Note: Digital high side only). The individual outputs can be set for High Side Operation, Low Side Operation, High Side Push Pull Operation, or Low Side Push Pull Operation.

Output (Drive) Modes:

1. Off mode: the output is not setup for activation, i.e., no functional use is intended.
2. Digital mode: the output is intended to provide a switched source of power to the load (i.e., a fixed non proportional output). This mode can be modified by selecting a Load Profile. The available Load Profiles include Normal, Constant Power, and Soft Start.
 - a. Normal: this Digital Load Profile is intended for loads that do not exhibit a high inrush current.
 - b. Constant Power: this Digital Load Profile is intended for use with active electronic loads that require constant power such as LED work lights and other electronic type loads that will have a much higher current draw when initially energized. For example, if multiple loads that integrate switching power supplies are connected to the output, very high peak current is initially demanded from that output. In this mode the output is allowed to drive current above the channel rating for less than 100ms to overcome the high inrush current required and then it reverts to normal digital operation. If the output is in overcurrent after 100ms, the output will shut down and an overcurrent fault will be generated. The output will then be commanded to 0.
 - c. Softstart: this Digital Load Profile integrates a soft start feature to effectively manage large inrush currents such as typically seen with large capacitive loads (please note that the soft start feature can be overridden by setting the timeout value to 0 seconds). The Softstart Load Profile implements a linear ramping function based on the formula $y=mx+b$, where y is the duty cycle, m is the slope, x is the step number (1 msec steps) and b is the intercept (the duty cycle % used as the first step). The softstart ramping is initiated when the digital output desired duty cycle changes from 0 to 100%. If the ramping output step causes an overcurrent event, the previous step duty cycle is used for a recovery period (user defined number of steps) before the ramping is continued. A cycle of step-overcurrent-recovery-step will repeat until the duty cycle value reaches 100% without an overcurrent event or until the softstart timeout limit is reached.
3. PWM mode: This mode is intended to provide open loop proportional control of loads such as electrohydraulic control valves. Commands are in % PWM duty cycle.

4. PWMi (PWM Closed Loop Current Control) mode: This mode is intended to provide closed loop proportional control of loads such as electrohydraulic control valves using current feedback. Commands are in mA.

Output (Drive) Profiles:

1. Single: This profile is intended for use when the output is used exclusively for the driven load and not in conjunction with any other output.
2. H-Bridge: In this profile two channels are setup for H-Bridge operation (typically for electric motor control). This mode allows the direction of rotation to be changed by effectively changing the polarity of the current path through the motor.
3. Parallel: In this profile two outputs are connected in parallel to drive a load that requires more current than the individual outputs are rated to deliver. This allows up to 25 amps to be sourced to the load (please note: High Side only operation with 15A channels).

Output Range:

Between 4, 8, or 10 4A channels can be configured in a Normal (4A) or Low Range (400 mA or less) mode depending on the controller model.

1. Normal: This Output Range is intended for use when the output must support up to the current rating (4A or 15A) of current. This is the default output range for all channels.
2. Low Range: This Output Range (only available on 4A channels) allows for a greater accuracy and resolution for low current loads (i.e., less than 400 mA) such as certain hydraulic pumps and valves that have integrated electronics.

Output Drive Type Operation:

1. High Side (HS): This drive type of operation is the typical standard output to turn a load On or Off when the load is connected to ground. The individual outputs can source up to 400 mA, 4 A or 15 A (H8 only) loads. This type output supports all four modes of operation, i.e., Off, Digital, PWM, and PWMi. Note that with this drive type the complementary low side channel is undriven leaving the output floating whenever the high side FET is off.
2. Low Side (LS): This drive type of operation is the typical standard output to turn a load On or Off when the load is connected to power. The individual outputs can sink up to 400 mA, 4 A or 15 A (H8 only) loads. This type of output supports all four modes of operation, i.e., Off, Digital, PWM, and PWMi. Note that with this drive type the complementary high side channel is undriven leaving the output floating whenever the low side FET is off.
3. High Side Push Pull (HSPP): This drive type of operation is used to turn a load On or Off when the load is connected to ground. The individual outputs can source up to 400 mA, 4 A or 15 A (H8 only) loads. This type of output supports all four modes of operation, i.e., Off, Digital, PWM, and PWMi. Note that with this drive type the

complementary low side channel is driven pulling the output to ground whenever the high side FET is Off.

4. Low Side Push Pull (LSPP): This drive type of operation is used to turn a load On or Off when the load is connected to power. The individual outputs can sink up to 400 mA, 4 A or 15 A (H8 only) loads. This type of output supports all four modes of operation, i.e., Off, Digital, PWM, and PWMi. Note that with this drive type the complementary high side channel is driven pulling the output to supply power whenever the low side FET is Off.

MCx Output Mode Configurations

Profile	Drive Mode	Drive Type	Switch Side	Dual Range	Load Profile
Single	Digital	HS-LS/Push-Pull	High Side/Low Side	Normal	Normal, Softstart, Constant Power
	PWM	HS-LS/Push-Pull	High Side/Low Side	Normal/Low	Normal
	Current Control	HS-LS/Push-Pull	High Side/Low Side	Normal/Low	Normal
H-Bridge	Digital	Push-Pull	High Side/Low Side	Normal	Normal, Softstart, Constant Power
	PWM	Push-Pull	High Side/Low Side	Normal/Low	Normal
	Current Control	Push-Pull	High Side/Low Side	Normal/Low	Normal
Parallel	Digital	HS-LS	High Side	Normal	Normal

Outputs I/O Mapping

The **Outputs I/O Mapping** tab displays the Channel State, Desired Duty Cycle, Actual Duty Cycle, Desired Current, Current Feedback, Digital (Binary) Output, H-Bridge Action, and Measured Voltage of the output channels.

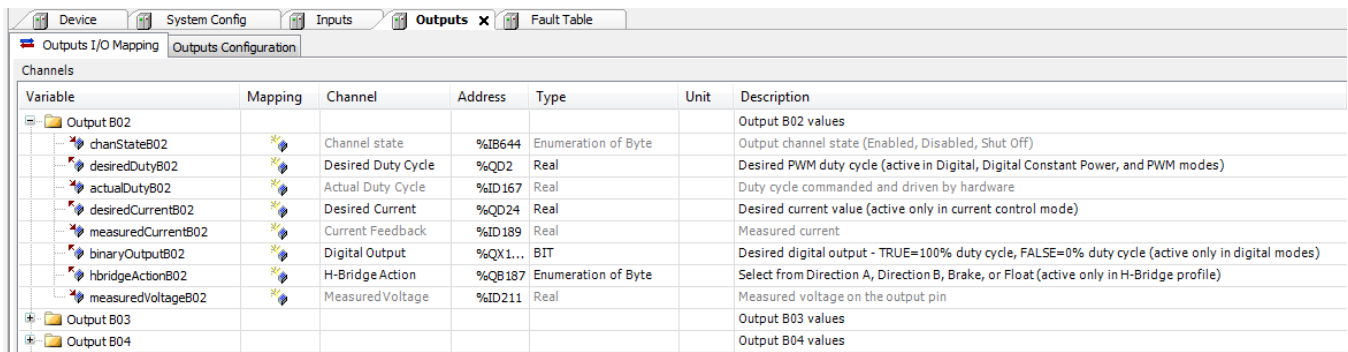

Outputs Configuration

Below is the **Outputs Configuration** tab. Up to 22 outputs can be configured depending on the controller model. The tab below is for the MC4-21-14-H8 which has 14 4A output channels

and 8 15A (high current) channels. As can be seen in the description, the first 8 channels are also dual range capable.

Parameter	Type	Value	Default Value	Unit	Description
Shared PWM Fault Configuration					Shared configuration parameters for detection of select PWM fault conditions
Output B05					Output B05 configuration (has dual range)
Output B06					Output B06 configuration (has dual range)
Output B17					Output B17 configuration (has dual range)
Output B18					Output B18 configuration (has dual range)
Output D03					Output D03 configuration (has dual range)
Output D05					Output D05 configuration (has dual range)
Output D15					Output D15 configuration (has dual range)
Output D17					Output D17 configuration (has dual range)
Output B02					Output B02 configuration
Output B03					Output B03 configuration
Output B04					Output B04 configuration
Output B14					Output B14 configuration
Output B15					Output B15 configuration
Output B16					Output B16 configuration
Output D02					Output D02 configuration (15A)
Output D04					Output D04 configuration (15A)
Output D06					Output D06 configuration (15A)
Output D09					Output D09 configuration (15A)
Output D11					Output D11 configuration (15A)
Output D14					Output D14 configuration (15A)
Output D16					Output D16 configuration (15A)
Output D18					Output D18 configuration (15A)

The image below shows the expanded configuration view of a single channel.

Parameter	Type	Value	Default Value	Unit	Description
Shared PWM Fault Configuration					Shared configuration parameters for detection of select PWM fault conditions
Output B05					Output B05 configuration (has dual range)
Channel rating	Enumeration of Byte	4 Amp	4 Amp		Current rating of the channel
Drive profile	Enumeration of Byte	Single	Single		Select single, H-bridge (paired channel A or B), or parallel (paired channel A or B) profile
Drive mode	Enumeration of Byte	Off	Off		Select digital, open-loop PWM duty-cycle, or closed-loop current control mode (valid for single and HBridge profiles; parallel profile m
Load profile	Enumeration of Byte	Normal	Normal		Select Normal, Constant Power, or Softstart output load profile (valid for digital drive mode only)
Drive type	Enumeration of Byte	HS-LS	HS-LS		Select HS-LS (High Side-Low Side) or Push-Pull output drive type (valid for single profile; HBridge profile is Push-Pull only; parallel pr
Switching side	Enumeration of Byte	High side	High side		Select between high side or low side output driver switching (valid for single and HBridge profiles; parallel profile is high side only)
Output range	Enumeration of Byte	Normal	Normal		Select between normal range (0-4A) or low range (0-400mA) output (low range valid for closed-loop current control mode only)
Dither wave type	Enumeration of Byte	Square wave	Square wave		Select between square or cosine dither wave type
Paired pin	Enumeration of UINT	None	None		Select connector/pin with which to pair (valid for HBridge and Parallel profiles only)
PWM Frequency	Word(1..5000)	500	500		The fundamental frequency used to drive the output driver (must be >= to dither frequency)
Dither Frequency	Word(1..1000)	100	100		Sub-frequency that is superimposed into the waveform by varying the duty cycle (must be <= to half of PWM frequency)
Dither Amplitude (duty cycle)	Byte(0..100)	0	0		The amount of peak-to-peak variation (in duty cycle percent) to use for dithering
Dither Current	Word	0	0		The amount of peak-to-peak variation (in mA) to use for dithering
Minimum command	Word(50..4000)	50	50		The minimum allowed commanded value for current control
Maximum command	Word(50..4000)	4000	4000		The maximum allowed commanded value for current control
Maximum parallel command	Word(50..6000)	6000	6000		The maximum allowed commanded value for current control (parallel profile only)
Kp	Real	0.25	0.25		Proportional gain (Kp) for current control loop
KJ	Real	8	8		Integral gain (KJ) for current control loop
Load Resistance	Real(0..50)	0	0		The estimated load resistance (R) of the driven circuit
HBridge action threshold	Word	250	250		Current threshold below which an HBridge channel must fall while braking before a change in direction is performed (only used with H
HBridge action timeout	Word	200	200		Amount of time an HBridge direction change will wait while breaking for the current to drop below the action threshold before an HBr
Overcurrent timeout	Word(0..500)	500	500		Overcurrent protection timeout - amount of time channel is in overcurrent before a fault is issued and channel is turned off
Overcurrent retry	Byte	4	4		Overcurrent protection retry - amount of time after an overcurrent event is detected before the channel is re-energized
Softstart slope	Real(0.1..10.0)	1.0	1.0		Digital output softstart ramping slope - duty cycle % increment per msec ("m" term of y = mx + b)
Softstart intercept	Real(0.0..10.0)	0.0	0.0		Digital output softstart ramping intercept ("b" term of y = mx + b)
Softstart ramping timeout	Word(0..4000)	100	100		Digital output softstart timeout - amount of time channel is in softstart ramping without reaching target duty cycle before a fault is is
Softstart recovery	Byte(0..10)	5	5		Digital output softstart recovery - the amount of time after an overcurrent event before continuing the ramp function
Softstart voltage drop	Word(70..8000)	2000	2000		Digital output softstart voltage drop limit that is indicative of a short-to-ground (at t > 100msec)
Softstart voltage drop short	Word(10..4000)	70	70		Digital output softstart voltage drop limit that is indicative of a short-to-ground (at t <= 100msec)
Enable Channel Faults	Bool	TRUE	TRUE		Set TRUE to enable automatic system fault processing for this PWM channel
Output B06					Output B06 configuration (has dual range)
Output B17					Output B17 configuration (has dual range)

The **Outputs Configuration** tab allows the selection of the output channel’s Drive Profile, Drive Mode, Load Profile (for Digital mode only), Drive Type, Switching Side, and Output Range (if dual range capable). Additional configuration settings include PWM Frequency and Dither values, Minimum/Maximum Command limits and PI control loop tuning parameters for current control, Overcurrent Timeout and Retry values, and Digital mode Softstart parameter definitions.

Shared Output (PWM) Fault Configuration

The **Outputs Configuration** tab also includes the **Shared PWM Fault Configuration** tab entry as shown below. The fault parameters under this entry are termed “Shared” because the fault criteria is shared across all output channels. This tab entry allows access to output fault parameters used by the firmware as criteria for evaluating and triggering faults, e.g., Load Connected to Power, Open Circuit, Short to Ground, etc. The default values for these fault parameters have been chosen so that most applications and output loads can be safely exercised. However, in rare and special cases one or more of these parameters may need to be adjusted to avoid unexpected triggering of a fault. Caution should be exercised when modifying the value of any of these fault parameters and should be performed only by an expert in the controller operation, application logic, and output load configuration.

Parameter	Type	Value	Default Value	Unit	Description
Shared PWM Fault Configuration					
Shared configuration parameters for detection of select PWM fault conditions (((High-side duty = DUTY_HS) and (Voltage > VFLOAT_RATIO)) OR ((HBridge duty = DUTY_HS) and (current sinking > SINK_CURRENT)))					
Load connected to power					
DUTY_HS	Byte(0..100)	0	0	%	Duty cycle at which to test for a high-side channel having a load connected to power
VFLOAT_RATIO	Byte(25..150)	125	125	% VFL...	Percentage of floating voltage above which a high-side channel is considered to have a load connected to power
SINK_CURRENT	Word(0..500)	5	5	mA	Sinking current above which HBridge channels are considered to have a load connected to power (((Duty > OPEN_DUTY) and (Current < OPEN_RATING_RATIO)) OR if low-side ((Duty = OPEN_DUTY_LS) and (voltage = ±OPEN_VFLOAT_RATIO)))
Open circuit					
OPEN_DUTY	Byte(0..100)	10	10	%	Duty cycle above which to test for a high-side channel open circuit
OPEN_RATING_RATIO	Byte(0..25)	2	2	% Rat...	Percentage of channel rating current under which an active high-side channel is considered open
OPEN_DUTY_LS	Byte(0..100)	0	0	%	Duty cycle at which to test for a low-side channel open circuit
OPEN_VFLOAT_RATIO	Byte(0..50)	25	25	% VFL...	Percentage of floating voltage within which a low-side channel is considered open (((Duty = GROUNDED_DUTY) and if low-side (voltage < GROUNDED_VFLOAT_RATIO)))
Short to ground					
GROUNDED_DUTY	Byte(0..100)	0	0	%	Duty cycle at which to test for a grounded output
GROUNDED_VFLOAT_RATIO	Byte(0..50)	25	25	% VFL...	Percentage of floating voltage under which a low-side channel is considered grounded ((Current > user limit) or (Current > (MAX_CURRENT + (MAX_CURRENT * MAX_CURRENT_MARGIN)))
Overcurrent					
MAX_CURRENT_MARGIN	Byte(0..15)	10	10	%	Margin above max current before an overcurrent fault is triggered
MAX_CURRENT_4A_LOW_RANGE	Word(0..400)	400	400	mA	Max current allowed on 4A channels configured for Low Range output
MAX_CURRENT_4A	Word(50..4000)	4000	4000	mA	Max current allowed on 4A channels
MAX_CURRENT_4A_PARALLEL	Word(50..5000)	6000	6000	mA	Max current allowed on 2 parallel (paired) 4A channels
MAX_CURRENT_15A	INT	15000	15000	mA	Max current allowed on 15A channels
MAX_CURRENT_15A_PARALLEL	INT	25000	25000	mA	Max current allowed on 2 parallel (paired) 15A channels
Unexpected (reverse) current					
UNEXPECTED_DUTY	Byte(0..100)	0	0	%	Duty cycle under which to test for unexpected (reverse) current
UNEXPECTED_CURRENT	Word(0..500)	100	100	mA	Amount of current in the reverse direction above which an active channel is considered to have unexpected current. Note: 15A channel limit is 4 times this value (Paired channel currents difference > ±IMBALANCE_DELTA_RATIO)
Current imbalance					
IMBALANCE_DELTA_RATIO	Byte(0..30)	10	10	%	Percentage of channel rating above which the difference in paired channel currents is considered to be imbalanced (((Off or Duty = LOSS_OF_CONTROL_DUTY) and (current > LOSS_OF_CONTROL_CURRENT)))
Loss of control					
LOSS_OF_CONTROL_DUTY	Byte(0..100)	0	0	%	Duty cycle at which to test for a loss of control of the output
LOSS_OF_CONTROL_CURRENT	Word(0..500)	100	100	mA	Amount of current on an inactive channel above which control of the channel is considered lost. Note: 15A channel limit is 4 times this value (Low range and (Duty > LOW_RANGE_MISMATCH_DUTY) and (normal range current feedback - low range current feedback > LOW_RANGE_MISMATCH_CURRENT)))
Low range mismatch					
LOW_RANGE_MISMATCH_DUTY	Byte(0..100)	0	0	%	Duty cycle at which to test for a current feedback mismatch
LOW_RANGE_MISMATCH_CURRENT	Word(0..200)	50	50	mA	Difference between normal range current feedback and low range current feedback above which the feedback is considered mismatched (low range saturation)
Extended Diagnostics					
Extended Diagnostics	Bool	FALSE	FALSE		Expand reporting of overcurrent output diagnostics to include low level driver faults Set to true to enable extended output diagnostic messages

Special Consideration: H-Bridge Mode

An H-Bridge is composed of two output channels that have the same Current Rating (both low range up to 400 mA, both 4A, or both 15A) and have been configured with the same Drive Mode (Digital, PWM, or PWMi), Load Profile, and Switching Side (High Side or Low Side). The two selected channels are configured as an H-Bridge by setting one channel to be the “A” leg of the H-Bridge and the other channel to be the “B” leg of the H-Bridge.

We will configure channels B05 and B06 as an example. The drive profile for channel B05 is changed from “Single” to “HBridge (Chan A)” so that it will be the “A” leg of the HBridge. The drive profile for channel B06 is changed from “Single” to “HBridge (Chan B)” so that it will be the “B” leg of the HBridge. Now we need to pair the channels together by setting the Paired Pin value of B05 to “B06” and the Paired Pin value of B06 to “B05”.

When this configuration is downloaded, the two channels become an HBridge and the two outputs are synchronized. Note that all shoot-through is safely handled by the hardware and firmware.

When it is time to energize the HBridge, the Desired Duty Cycle, Binary Output, or Desired Current is set depending on the Drive Mode. Then the HBridge Action is set to one of “Direction A”, “Direction B”, “Brake”, or “Float”.

Assuming the HBridge starts out in “Direction A”, when a change of direction is desired the HBridge action can be set to “Direction B”. The controller will recognize the change in direction and will automatically apply a “Brake” directive to the HBridge until the current feedback indicates that the current has dropped below the user defined HBridge Action Threshold. Once the current has dropped below the threshold, “Direction B” is initiated. If the current does not drop below the threshold within the user defined HBridge Action Timeout, a warning is issued but the change of direction is still initiated.

Over Current Shut Down

In general, the individual outputs of the unit are fully protected and will switch Off if overloaded. When diagnostics are enabled (default) and an overcurrent event occurs, the output will switch Off (set the duty cycle to 0%) and remain Off until the fault is cleared by the user/application. This fault will recur if the cause of the overcurrent is not addressed and corrected.

In all output drive modes after the output has been energized and correctly powering a load, when an overcurrent event initially occurs the output will rapidly switch Off and then back On (retry) at 4 msec intervals until the current drops below the overload setpoint or the overcurrent timeout is exceeded. If the timeout is exceeded, the output will switch Off and the output desired command will be overridden to 0% duty cycle or 0 mA current.

The overcurrent shutdown limits are dependent upon the specific output:

- 15 A rated outputs have an overload setpoint default of 16.5 A; if this level is exceeded for 500 msec, the output will switch Off.
- 4 A rated outputs have an overload setpoint default of 4.4 A; if this level is exceeded for 500 msec, the output will switch Off.
- 400 mA rated (dual range/low range) outputs have an overload setpoint default of 440 mA; if this level is exceeded for 500 msec, the output will switch Off.

Fault Table

A fault table is integrated in the IDE. Please see the samples below. When a fault occurs, an exclamation will appear on the “Fault Table” icon indicating “Diagnostic message available”.

If there is an active fault that relates to an Input or Output channel, then the respective icon will also display the red triangle.

Fault Table I/O Mapping

The **Fault Table I/O Mapping** tab is a convenient location where all active and historic faults can be viewed. Additionally, user-defined faults from the IEC application can be set here for monitoring. Fault details can be found in Appendix.

Variable	Ma...	Channel	Address	Type	Current ...	Pre...	Unit	Description
Faults that can be set by IEC code								
Active and historic fault status for system/firmware level faults								
View each systems fault's active status								
systemFaultsActive			%I948.0	ARRAY...	[0,0,0,0...			
sys_t_max_shutdown is active (Index=129)			%IX948.0	BOOL	FALSE			TRUE if "System overtemperature shutdown" fault is active
sys_t_max_warning is active (Index=130)			%IX948.1	BOOL	FALSE			TRUE if "System overtemperature warning" fault is active
sys_t_min_shutdown is active (Index=131)			%IX948.2	BOOL	FALSE			TRUE if "System undertemperature warning" fault is active
sys_t_max_shutdown is active (Index=132)			%IX948.3	BOOL	FALSE			TRUE if "System overcurrent shutdown" fault is active
sys_t_max_warning is active (Index=133)			%IX948.4	BOOL	FALSE			TRUE if "System overcurrent warning" fault is active
V_max_shutdown is active (Index=134)			%IX948.5	BOOL	FALSE			TRUE if "Battery voltage high shutdown" fault is active
V_max is active (Index=135)			%IX948.6	BOOL	FALSE			TRUE if "Battery voltage high warning" fault is active
V_min is active (Index=136)			%IX948.7	BOOL	FALSE			TRUE if "Battery voltage low warning" fault is active
V_sensor_supply1_max is active (Index=137)			%IX949.0	BOOL	FALSE			TRUE if "Sensor supply #1 over voltage" fault is active
V_sensor_supply1_min is active (Index=138)			%IX949.1	BOOL	FALSE			TRUE if "Sensor supply #1 under voltage" fault is active
V_sensor_supply2_max is active (Index=139)			%IX949.2	BOOL	FALSE			TRUE if "Sensor supply #2 over voltage" fault is active
V_sensor_supply2_min is active (Index=140)			%IX949.3	BOOL	FALSE			TRUE if "Sensor supply #2 under voltage" fault is active
VLoad_max is active (Index=141)			%IX949.4	BOOL	FALSE			TRUE if "Load power voltage high" fault is active
VLoad_min is active (Index=142)			%IX949.5	BOOL	FALSE			TRUE if "Load power voltage low" fault is active
VLoad_imbalance is active (Index=143)			%IX949.6	BOOL	FALSE			TRUE if "Supply power imbalance" fault is active
SSR_imbalance is active (Index=144)			%IX949.7	BOOL	FALSE			TRUE if "SSR imbalance" fault is active
COPfail is active (Index=145)			%IX950.0	BOOL	FALSE			TRUE if "COP failure" fault is active
RTI1 is active (Index=146)			%IX950.1	BOOL	FALSE			TRUE if "RTI 1 loss" fault is active
RTI2 is active (Index=147)			%IX950.2	BOOL	FALSE			TRUE if "RTI 2 loss" fault is active
RTI3 is active (Index=148)			%IX950.3	BOOL	FALSE			TRUE if "RTI 3 loss" fault is active
ADloss is active (Index=149)			%IX950.4	BOOL	FALSE			TRUE if "A/D loss" fault is active
Interrupt is active (Index=150)			%IX950.5	BOOL	FALSE			TRUE if "Invalid interrupt" fault is active
flash_fail is active (Index=151)			%IX950.6	BOOL	FALSE			TRUE if "Flash checksum invalid" fault is active
RAM_fail is active (Index=152)			%IX950.7	BOOL	FALSE			TRUE if "RAM failure" fault is active
MDAM_fail is active (Index=153)			%IX950.8	BOOL	FALSE			TRUE if "MDAM failure" fault is active

TRUE if "PWM1 (B02) Open" fault is active

Reset mapping Always update variables: Enabled 1 (use bus cycle task if not used in any task)

Create new variable Map to existing variable

Last build: 0 0 Precompile: RUN Program loaded - Force active Program modified (Full download) Current user: (nobody)

Status

One message is displayed at a time in the Fault Table **Status** tab. When Acknowledge is selected, the current fault is cleared, and the next fault is displayed. If the fault cannot be cleared, it will remain until the condition is fixed.

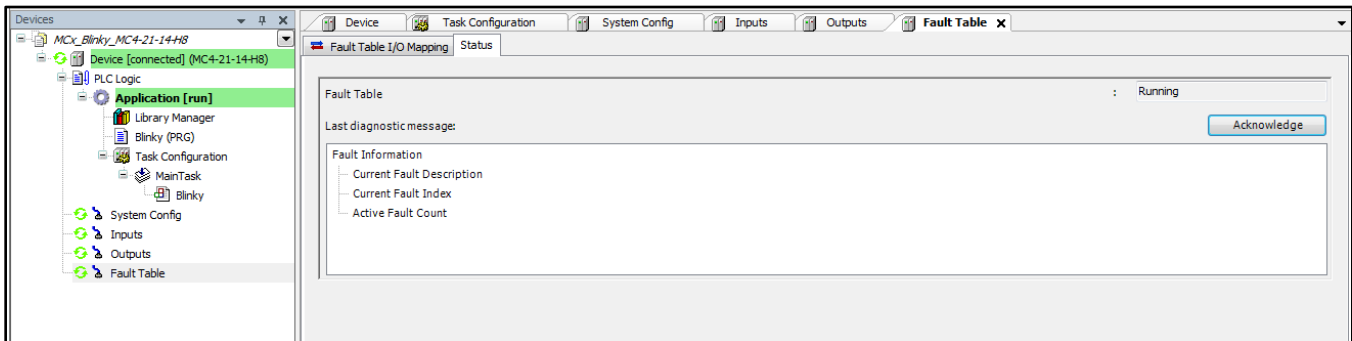
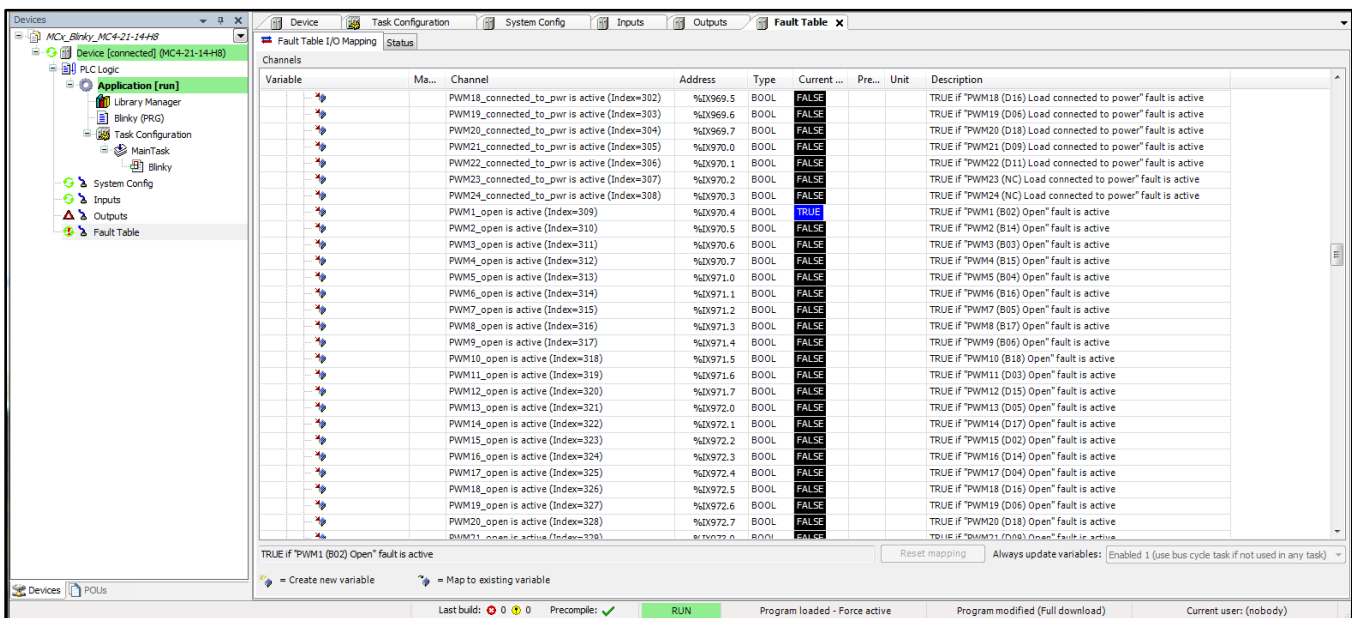
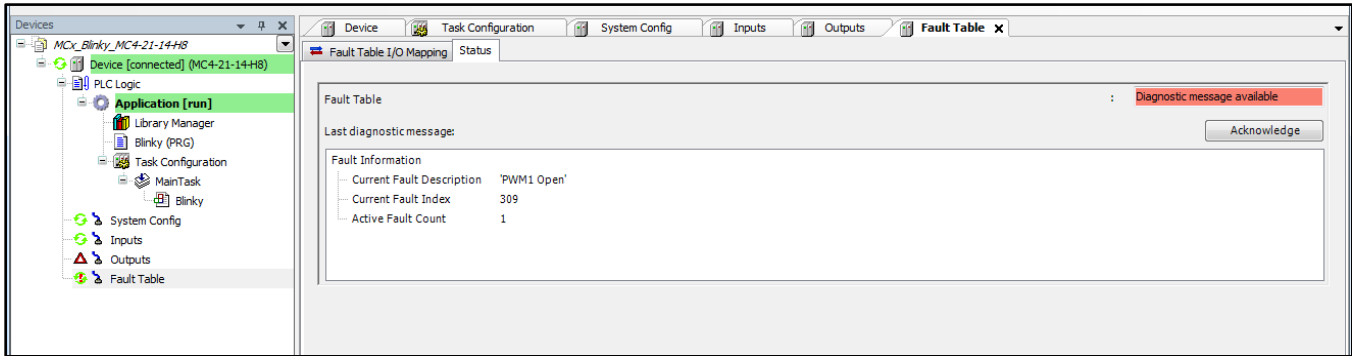

Appendix A – Fault Conditions

The controller features a reserved area for up to 128 user defined IEC faults in the configuration. This is very flexible as all faults can be easily scanned through in one area of the environment. In addition to the user-defined faults, several system faults are also available for mapping into your control program to both improve system performance and enhance diagnostic coverage. The range limits for most of the faults have default values that can be overwritten. Please note that there are both active and historic faults.

Note:

Important: Faults that shut down an output and/or the SSR will have this fault behavior underlined. The other faults are only warnings.

Fault Data Structure

StructType name = “flt_diag_struct”: this is the entire fault data structure.

Component identifier = “fault description”: this is the fault description.

Component identifier = “cur_index”: this is the fault index (fault number).

Component identifier = “fault_index”: this is the active fault count.

Fault descriptions

Set User Fault # xx active: (xx implies 1 -128) This is a set of user-defined faults that can be set (active) and reset within the application.

User Fault # xx is historic: (xx implies 1 -128) This is a set historic faults linked to the above set of user defined faults that occur initially when the user defined fault is no longer active.

The faults listed below are a set of system faults that can be set by the IEC code. Although the faults listed are all the active faults, the same fault reference can also be historic.

System Faults

setsysfault129: This is the System overtemperature shutdown fault. This fault occurs whenever sys_T_max_shutdown is active. The internal controller rail temperature is monitored and if it exceeds 145°C for over 3 seconds the fault becomes active. This will reset if the temperature drops below 145°C for over 5 seconds. We recommend the user shutdown, but this fault is only a warning.

setsysfault130: This is the System overtemperature warning fault. This fault occurs whenever sys_T_max_warning is active. The internal controller rail temperature is monitored

and if it exceeds 135°C for over 3 seconds the fault becomes active. This will reset if the temperature drops below 135°C for over 5 seconds. This fault is a warning.

setsysfault131: This is the System undertemperature warning fault. “This occurs whenever sys_T_min is active. The internal controller rail temperature is monitored and if it drops below -35°C for over 3 seconds the fault becomes active. This will reset if the temperature increases above -35°C for over 5 seconds. This fault is a warning.

setsysfault132: This is the System overcurrent shutdown fault. It occurs when sys_I_max_shutdown is active. This occurs whenever the total output current sourced and sinked exceeds the unit total current rating by greater than 2.5% for over 1 second. A manual reset will be allowed if the current drops below the 2.5% level for over 5 seconds. The SSR is shut down and all outputs are turned off (duty cycle set to 0%) if this fault is activated.

setsysfault133: This is the System overcurrent warning fault. It occurs when sys_I_max_warning is active. This occurs whenever the total output current sourced and sinked exceeds the unit total current rating of the controller but is less than 2.5% above the rating for over 1 second. This fault will reset if the current drops below the unit current rating for over 5 seconds. This fault is a warning.

setsysfault134: This is the Battery voltage high shutdown fault. It occurs when V_max_shutdown is active. This occurs whenever the supply voltage exceeds 38 V for more than 0.75 seconds. The fault is reset whenever the voltage drops below 38 V for more than 1.25 seconds. We recommend the user shutdown. This fault will prevent outputs from energizing.

setsysfault135: This is the Battery voltage high warning fault. It occurs when V_max is active. This occurs whenever the Battery voltage (VBat) exceeds 36 V for more than 3 seconds. The fault is reset whenever the voltage drops below 36 V for more than 5 seconds. This fault is a warning.

setsysfault136: This is the Battery voltage low warning fault. It occurs when V_min is active. This occurs whenever VBat drops below 7 V for more than 3 seconds. The fault resets if the voltage increases above 7 V for at least 0.1 seconds. This fault will prevent outputs from energizing.

setsysfault137: This is the Sensor supply #1 overvoltage fault. It occurs when V_Sensor_supply1_max is active. This fault indicates that Sensor Supply 1 is inadvertently connected (shorted) to a source of power with a higher voltage than the sensor supply is set at, i.e., 5% > 5 or 10 VDC. The fault occurs when the nominal supply voltage exceeds its rating for 1 second and resets when the nominal supply voltage drops below this level for 2 seconds. This fault is a warning.

setsysfault138: This is the Sensor supply #1 undervoltage fault. It occurs when V_Sensor_supply1_min is active. This fault indicates that Sensor Supply 1 is either overloaded or shorted to ground. The fault occurs when the sensor supply output drops by

> 15% of its nominal 5V or 10V setting for over 1 second and resets when the voltage increases above this threshold for over 2 seconds. This fault is a warning.

setsysfault139: This is the Sensor supply #2 overvoltage fault. It occurs when V_Sensor_supply2_max is active. This fault indicates that Sensor Supply 2 is inadvertently connected (shorted) to a source of power with a higher voltage than the sensor supply is set at, i.e., 5% > 5 or 10 VDC. The fault occurs when the nominal supply voltage exceeds rating for 1 second and resets when the nominal supply voltage drops below this level for 2 seconds. This fault is a warning.

setsysfault140: This is the Sensor supply #2 undervoltage fault. It occurs when V_Sensor_supply2_min is active. This fault indicates that Sensor Supply 2 is either overloaded or shorted to ground. The fault occurs when the sensor supply output drops by > 15% of its nominal 5V or 10V setting for over 1 second and resets when the voltage increases above this threshold for over 2 seconds. This fault is a warning.

setsysfault141: This is the Load power voltage (VLoad) high fault. It occurs when VLoad_max is active. This fault indicates that Load Power voltage is high. This occurs whenever VLoad exceeds 36 V for more than 3 seconds. VLoad must drop below 36 V for 5 seconds to reset. This fault is a warning.

setsysfault142: This is the Load Power voltage low fault. It occurs when VLoad_min is active. This fault indicates that Load Power voltage is low. This occurs whenever VLoad drops below 7 V for more than 3s seconds. VLoad must rise above 7 V for 5 seconds in order to reset. This fault will prevent outputs from energizing.

setsysfault143: This is the Supply (Load) Power imbalance fault. It occurs when VLoad_imbalance is active. This occurs when the Solid State Relay (SSR) is ON and there is more than a 1 V difference between the VBat and VLoad supplies for more than 1 second. This fault shuts down the SSR and all outputs.

setsysfault144: This is the Solid State Relay (SSR) imbalance fault. It occurs when SSR_imbalance is active. It occurs when the SSR is ON and there is more than 0.5V difference between the Load Power voltage measured before the SSR and the Load Power voltage measured after the SSR for more than 1 second. This fault shuts down the SSR and all outputs.

setsysfault145: This is the Computer Operating Properly (COP) watchdog/system monitor fault. It occurs when COPfail is active. This fault occurs if the controller firmware locks up such that the COP is not reset approximately every 100 msec and indicates a firmware failure.

setsysfault146: This is the Real-Time Interrupt #1 (RTI1) fault. It occurs when RTI1 is active. This fault indicates that the 1 msec internal firmware loop watchdog expired and the loop is not executing. This indicates a firmware failure.

setsysfault147: This is the Real-Time Interrupt #2 (RTI2) fault. It occurs when RTI2 is active. This fault indicates that the 5 msec internal firmware loop watchdog expired and the loop is not executing. This indicates a firmware failure.

setsysfault148: This is the Real-Time Interrupt #3 (RTI3) fault. It occurs when RTI3 is active. This fault indicates that the 50 msec internal firmware loop watchdog expired and the loop is not executing. This indicates a firmware failure.

setsysfault149: This is the Analog-to-Digital Converter (ADC) Loss fault. It occurs when ADloss is active. This fault indicates that the ADC routine is not running for some reason as detected by a watchdog monitoring the ADC operation.

setsysfault150: This is the invalid interrupt fault. It occurs when *interrupt* is active. This fault indicates an invalid/unhandled interrupt has occurred.

setsysfault151: This is the Flash Failure fault. It occurs when flash_fail is active. This fault indicates a nonvolatile memory storage hardware error.

setsysfault152: This is the Random Access Memory (RAM) fault. It occurs when RAM_fail is active. This fault indicates a volatile memory hardware error.

setsysfault153: This is the Magnetoresistive Random Access Memory (MRAM) fault. It occurs when MRAM_fail is active. This fault indicates a retained or persistent memory hardware error.

setsysfault154: This is the Hardware Identification Failure fault. It occurs when HWID_fail is active. Two specific resistors are present on the printed circuit board (PCB) that are used to identify the hardware version. If these resistor values are unknown or cannot be read by the firmware, this fault will be triggered.

setsysfault155: This is the Controller Area Network (CAN) channel 1 transmit failure fault. It occurs when CAN1_TxFail is active. The fault indicates that the channel's CAN transmit error counter exceeds 100 errors.

setsysfault156: This is the CAN channel 2 transmit failure fault. It occurs when CAN2_TxFail is active. The fault indicates that the channel's CAN transmit error counter exceeds 100 errors.

setsysfault157: This is the CAN channel 3 transmit failure fault. It occurs when CAN3_TxFail is active. The fault indicates that the channel's CAN transmit error counter exceeds 100 errors.

setsysfault158: This is the CAN channel 1 receive failure fault. It occurs when CAN1_RxFail is active. The fault indicates that the channel's CAN receive error counter exceeds 100 errors.

setsysfault159: This is the CAN channel 2 receive failure fault. It occurs when CAN2_RxFail is active. The fault indicates that the channel's CAN receive error counter exceeds 100 errors.

setsysfault160: This is the CAN channel 3 receive failure fault. It occurs when CAN3_RxFail is active. The fault indicates that the channel's CAN receive error counter exceeds 100 errors.

setsysfault161: This is the incompatible target Device Descriptor file fault. It occurs when DevDesc_error is active. This fault indicates that there is a mismatch between the firmware and the CODESYS device descriptor XML file.

setsysfault162: This is the Illegal Flash Write fault. It occurs when illegal_flash_write is active. This fault indicates that the CODESYS runtime or application is attempting to write to a restricted address in flash.

setsysfault163: This is the CPU Addressing Error fault. It occurs when cpu_addr_err is active. This fault indicates that the CPU has attempted to read or write an illegal or mis-aligned address. CODESYS will sometimes trigger this fault if you do not do a "clean all" before pushing a modified application.

setsysfault164: This is the Illegal Instruction fault. It occurs when illegal_instr is active. This fault indicates that the CPU has attempted to execute an illegal instruction. In many cases this fault can be triggered when the application stack is too small and has overflowed.

setsysfault165: This is the Floating Point Unit (FPU) Exception fault. It occurs when FPU_exception is active. This fault indicates the FPU has encountered an error. This malfunction is specific to the floating point arithmetic unit.

setsysfault166: This is the CODESYS Triggered Exception fault. It occurs when CODESYS_exception is active. CODESYS has its own exception implementation. Take for example the watchdog you can enable for each task. If you enable the task watchdog and violate it then CODESYS throws an exception and displays an error message in the IDE. This fault mirrors that indication.

setsysfault167: This is the CODESYS Watchdog Exception fault. It occurs when CODESYS_watchdog is active. This fault indicates that the CODESYS runtime is not executing in a timely manner. The watchdog monitors the internal CODESYS task in firmware that executes the CODESYS runtime. This is subtly but significantly different from the watchdog that is enabled in CODESYS via the IDE. The fault will trigger if CODESYS locks up for any reason. For example, assume there is an infinite loop (e.g., while(TRUE){}) in IEC application code. Since all tasks run from a single context, the CODESYS runtime will never see that the infinite loop has locked up. However, the operating system will detect that the runtime has expired its watchdog and will in turn trigger this fault. The watchdog time for this is configured in 'CODESYS Runtime Watchdog' under the System Config Configuration tab. The

default for the 'CODESYS Runtime Watchdog' is 2 seconds so your individual task watchdog should be less."

setsysfault168: This is the CODESYS Memory Buffer Overrun fault. It occurs when `CODESYS_mem_buf_ovrun` is active. This fault indicates that the CODESYS runtime has exceeded its available memory.

setsysfault169: This is the CODESYS Low Dynamic Memory fault. It occurs when `CODESYS_low_mem` is active. This fault indicates that the CODESYS runtime is running low on memory. There is 16KB of internal 'dynamic' memory that is allocated to CODESYS. This is used for all CODESYS related code. The EDIS `DebugCodesys` page displays statistics on the Dynamic Memory usage.

setsysfault170: This is the CODESYS Out-Of-Dynamic-Memory fault. It occurs when `CODESYS_out_of_dyn_mem` is active. This fault indicates that the CODESYS runtime is out of dynamic memory.

setsysfault171: This is the CODESYS Bad Pointer Received fault. It occurs when `CODESYS_bad_pointer` is active. This fault indicates that the CODESYS runtime has encountered a pointer to bad memory or memory that is outside of its valid address range.

setsysfault172: This is the C-API Incompatible Version fault. It occurs when `C_API_incompatible_ver` is active. This fault indicates that the C-API version is incompatible with the firmware version executing on the controller.

setsysfault173: This is the C-API Debug Assertion Failed fault. This occurs when `C_API_Debug_Assertion_Failed` is active. This fault indicates that an assertion was triggered in the C-API application running on the controller. This is specific to C-API applications.

setsysfault174: This is the C-API 1 msec Watchdog Expired fault. This occurs when `C_API_1MS_watchdog_expired` is active. This fault indicates that the C-API application 1 msec loop did not complete in a timely manner or is not running when defined. This is specific to C-API applications.

setsysfault175: This is the C-API 5 msec Watchdog Expired fault. This occurs when `C_API_5MS_watchdog_expired` is active. This fault indicates that the C-API application 5 msec loop did not complete in a timely manner or is not running when defined. This is specific to C-API applications.

setsysfault176: This is the C-API 10 msec Watchdog Expired fault. This occurs when `C_API_10MS_watchdog_expired` is active. This fault indicates that the C-API application 10 msec loop did not complete in a timely manner or is not running when defined. This is specific to C-API applications.

setsysfault177: This is the C-API 50 msec Watchdog Expired fault. This occurs when `C_API_50MS_watchdog_expired` is active. This fault indicates that the C-API application 50

msec loop did not complete in a timely manner or is not running when defined. This is specific to C-API applications. NOTE: The 50 msec loop is no longer available for C-API applications.

setsysfault178: This is the C-API Background Watchdog Expired fault. This occurs when C_API_Bkgrnd_watchdog_expired is active. This fault indicates that the C-API application background task did not complete in a timely manner or is not running. This is specific to C-API applications.

setsysfault179: This is the Background Task Watchdog Expired fault. This occurs when Bkgrnd_task_watchdog_expired is active. This fault indicates that the firmware background task watchdog expired which implies the background task is not running. The CODESYS runtime is executing from the firmware background task. This fault points to an application coding problem where the program cycle time is preventing the execution of the background task (e.g., infinite loop).

Input Faults

NOTE: The following Input faults are defined for each input channel, i.e., channels 1-26. The fault descriptions below use “xx” to indicate the input channel range. When the fault is triggered and displayed, the “xx” from the descriptions below will be replaced by the respective channel number on which the fault occurred.

setsysfault180 – 205: These are the Input Overcurrent faults. These occur when AINxx_overcurrent is active. These faults indicate that the max current for input channel xx in has been exceeded, i.e., in current mode of operation a current above 24 mA has been measured.

setsysfault206 – 231: These are the Input Value Over-range faults. These occur when AINxx_max_val is active. These faults indicate that the value of the signal on input channel xx is too high. The input channel value is unit converted and interpreted based on the input mode of the channel. For example, if the channel is in Input Mode 0-36V, this fault will trigger when the input voltage exceeds 36V.

setsysfault232 – 257: These are the Input Value Under-range faults. These occur when AINxx_min_val is active. These faults indicate that the value of the signal on input channel xx is too low. The input channel value is unit converted and interpreted based on the input mode of the channel. For example, if the channel is in Input Mode 0-36V, this fault will trigger when a negative voltage less than ground is present.

setsysfault258 – 283: These are the Input Frequency Limit Exceeded faults. These occur when AINxx_max_freq is active. These faults indicate that the max frequency for input channel xx in Frequency Mode has been exceeded (>50 kHz).

setsysfault284: This is the Max Total Input Frequency Exceeded fault. It occurs when Max_freq_limit is active. This fault indicates that the maximum aggregate frequency for all input channels has been exceeded (>200kHz).

Output Faults

NOTE: The following PWM faults are defined for each output channel, i.e., channels 1-24. The fault descriptions below use “xx” to indicate the output channel range. When the fault is triggered and displayed, the “xx” from the descriptions below will be replaced by the respective channel number on which the fault occurred.

setsysfault285 - 308: These are the Load Connected to Power faults. These occur when PWMxx_short_vbat is active. These faults indicate that output channel xx has a short to the battery. The short to battery is detected for a high side output when the output is undriven (duty cycle = 0%) and the pin voltage is > 125% of VFloat (approximately 11.25V [12V system] or 22.5V [24V system]) for at least 500 msec.

setsysfault309 – 332: These are the Open Circuit faults. These occur when PWMxx_open is active. These faults indicate when there is an open circuit detected on output channel xx. The open circuit is detected for a high side output when it is driven at a duty cycle > 10% and the measured current is less than 2% of the channel rating (4A or 15A). The open circuit is detected for a low side output when it is not driven (duty cycle = 0%) and the measured pin voltage is \pm 25% of VFloat (approximately 2.25V [12V system] or 4.5V [24V system]) for at least 1 second.

setsysfault333 – 356: These are the Short to Ground faults. These occur when PWMxx_short_to_ground is active. These faults indicate when there is a short to ground on output channel xx. The short to ground fault is detected for a low side output when it is undriven (duty cycle = 0%) and the measured pin voltage is < 25% of VFloat (approximately 2.25V [12V system] or 4.5V [24V system]) for at least 250 msec.

setsysfault357 – 380: These are the Overcurrent faults. These occur when PWMxx_over_current is active. These faults indicate when there is an overcurrent protection event on output channel xx. The overcurrent fault is detected when the current measured for the output is greater than a user-definable limit or greater than 10% over the default maximum current of 400 mA (low range mode), 4000 mA (4A channel), 15000 mA (15A channel), 25000 mA (paired parallel 15A channels) for at least 500ms. This fault shuts down the associated output channel.

setsysfault381 – 404: These are the Unexpected (Reverse) Current faults. These occur when PWMxx_unexpected_current is active. These faults indicate that current was detected flowing in the opposite direction than expected. The unexpected current is detected when the duty cycle > 0% and 100 mA or more current is flowing in the wrong direction (a high side output has 100 mA or more of negative current or a low side output has 100 mA or more of positive current) for more than 500 msec. Note that the 100 mA limit is for 4A channels. The

15A channel limit is four times that at 400 mA. This fault shuts down the associated output channel.

setsysfault405 – 428: These are the Current Imbalance faults. These faults occur when PWMxx_current_imbalance is active. These faults indicate that the current measured on paired channels (HBridge or Parallel Drive Profiles) is not evenly balanced. The current imbalance fault is detected when the current measured on the two paired channels differ by more than 10% of the channel rating (400 mA for 4A channels; 1500 mA for 15A channels) for more than 500 msec. This fault shuts down the associated paired output channels.

setsysfaults429 – 452: These are the HBridge Action Timeout faults. These faults occur when PWMxx_HBridge_action_timeout is active. These faults indicate that while the system brake was being applied to the HBridge output it took longer than the user defined HBridge Action Timeout for the output current to drop to the user defined HBridge Action Threshold prior to a change in direction. Note that system brake is applied automatically when a change a direction is commanded. These faults are warnings and do not keep the change in direction from occurring.

setsysfault453 – 476: These are the Loss of Control faults. These faults occur when PWMxx_loss_control is active. These faults indicate that current exceeding 100 mA is flowing when the channel is OFF or has a 0% duty cycle for over 500 ms. Note that the 100 mA limit is for 4A channels. The 15A channel limit is four times that at 400 mA. This fault shuts down the SSR and all outputs.

setsysfault477 – 500: These are the Low Range Mismatch faults. These occur when PWMxx_lrng_mismatch is active. These faults indicate that the current measured via the low range sense amplifier and the current measured via the normal range current sense amplifier differ by more than 50 mA for over 500 ms. This check is performed since the low range current sense amplifier saturates when the current is greater than 500 mA. This fault shuts down the associated output channel.

Output Driver Faults

NOTE: The following Output Driver faults are defined for each output driver hardware chip, i.e., drivers 1-8. The fault descriptions below use “nn” to indicate the output driver. When the fault is triggered and displayed, the “nn” from the descriptions below will be replaced by the respective driver number on which the fault occurred or was reported. Each output driver supports up to three (3) output channels. If the driver has an error that requires it to shut down, all outputs associated with the driver will be shut down. The following table lists the output channels associated with each driver for all controller models.

Output Driver to Channels/Pins Mapping

Output Driver to Channels/Pins Mapping								
Driver	MC4-26-20		MC4-21-14-H8		MC3-21-10		MC2-18-6	
	Channels	Pins	Channels	Pins	Channels	Pins	Channels	Pins
1	1, 5, 3	B02, B04, B03	1, 5, 3	B02, B04, B03	1, 2, 3	B02, B14, B03	1, 2, 3	E02, E03, E08
2	10, 7, 9	B18, B05, B06	10, 7, 9	B18, B05, B06	4, 5, 6	B15, B04, B16	4, 5, 6	E09, E13, E14
3	14, 18, 2	C17, C16, B14	14, 12, 2	D17, D15, B14	7, 8, 9	B05, B17, B06	N/A	N/A
4	8, 4, 6	B17, B15, B16	8, 4, 6	B17, B15, B16	10	B18	N/A	N/A
5	17, 11, 15	C04, C03, C02	13, 11	D05, D03	N/A	N/A	N/A	N/A
6	20, 19, 13	C18, C06, C05	20, 19, 15	D18, D06, D02	N/A	N/A	N/A	N/A
7	16, 12	C14, C15	16, 21, 22	D14, D09, D11	N/A	N/A	N/A	N/A
8	N/A	N/A	18, 17	D16, D04	N/A	N/A	N/A	N/A

setsysfault501 – 508: These are the Output Driver Configuration Error faults. These occur when `Output_drvnn_config_error` is active. These faults indicate that the hardware driver does not report back the expected configuration register values. This fault shuts down the associated output channels.

setsysfault509 – 516: These are the Output Driver Overtemperature Warning faults. These occur when `Outpdrvnn_overtemp_warning` is active. These faults indicate that the die temperature exceeds the driver chip's thermal warning trip point. This fault is asserted when the driver reports an overtemperature warning. The fault will clear automatically once the temperature falls below the hysteresis point.

setsysfault517 – 524: These are the Output Driver Overtemperature Shutdown faults. These occur when `Outpdrvnn_overtemp_shutdown` is active. These faults indicate that the die temperature exceeds the driver chip's thermal shutdown trip point. This fault is asserted when the driver reports an overtemperature shutdown. The driver disables the associated output MOSFETS when it reports the overtemperature shutdown. This fault shuts down the associated output channels.

setsysfault525 – 548: These are the Gate Driver faults. These occur when `PWMxx_gate_drv_fault` is active. These faults indicate that output driver associated with the channel has detected a high side gate drive fault. The driver reports this fault when the gate voltage on the external MOSFET does not increase or decrease after a predefined `Tdrive` amount of time. The associated MOSFET is disabled. This fault shuts down the associated output channel.

setsysfault549 – 572: These are the Overcurrent Hardware Protection faults. These occur when `PWMxx_output_protection` is active. These faults indicate an output driver high side or low side VDS overcurrent has been detected. A MOSFET overcurrent event is sensed by monitoring the VDS voltage drop across the external MOSFET Drain source resistance. If the voltage exceeds the threshold for longer than the deglitch time, the driver reports an overcurrent. Once acknowledged by the firmware, the driver overcurrent indicator is cleared and the output is suspended for Overcurrent Retry number of msec. The output is then energized. If an overcurrent is still detected, the output will continue in the retry cycle. If 500 msec have elapsed and the overcurrent is still present, then the Overcurrent Hardware Protection fault is triggered and the associated channel is shutdown. The fault can be cleared by the user once the cause of the overcurrent condition has been corrected. The output function can then be restored by the user. This fault shuts down the associated output channel.

setsysfault573 – 580: These are the Output Driver Supply Undervoltage Lockout faults. These occur when `Outpdrvnn_supply_undervoltage` is active. These faults indicate that the supply voltage available to the output driver has dropped below the operable threshold. These faults may trigger if `VLoad` momentarily droops too low. This fault will clear automatically once the appropriate voltage level has been restored. This fault shuts down the associated output channels.

[setsysfault581 – 588: These are the Output Driver Charge Pump Undervoltage faults. These faults occur when `Outpdrvnn_chrgpump_undervolt` is active. These faults indicate that

the voltage from the charge pump falls below the operable threshold voltage. Normal operation can be restored when the undervoltage condition is removed. This fault shuts down the associated output channels.

setsysfault589 – 612: These are the Softstart Timeout faults. These faults occur when PWMxx_ss_timeout is active. These faults indicate that the digital output softstart ramping function failed to reach 100% duty cycle within a user-defined time period (Softstart Ramping Timeout). This fault shuts down the associated output channel.

Appendix B – Input Circuit Resistor Network

Below is a representation of the analog input circuit and it depicts the various pull-ups and pull-downs that allow for various different operational modes required for interfacing different input devices.

Analog Input Circuit (Passive Representation)

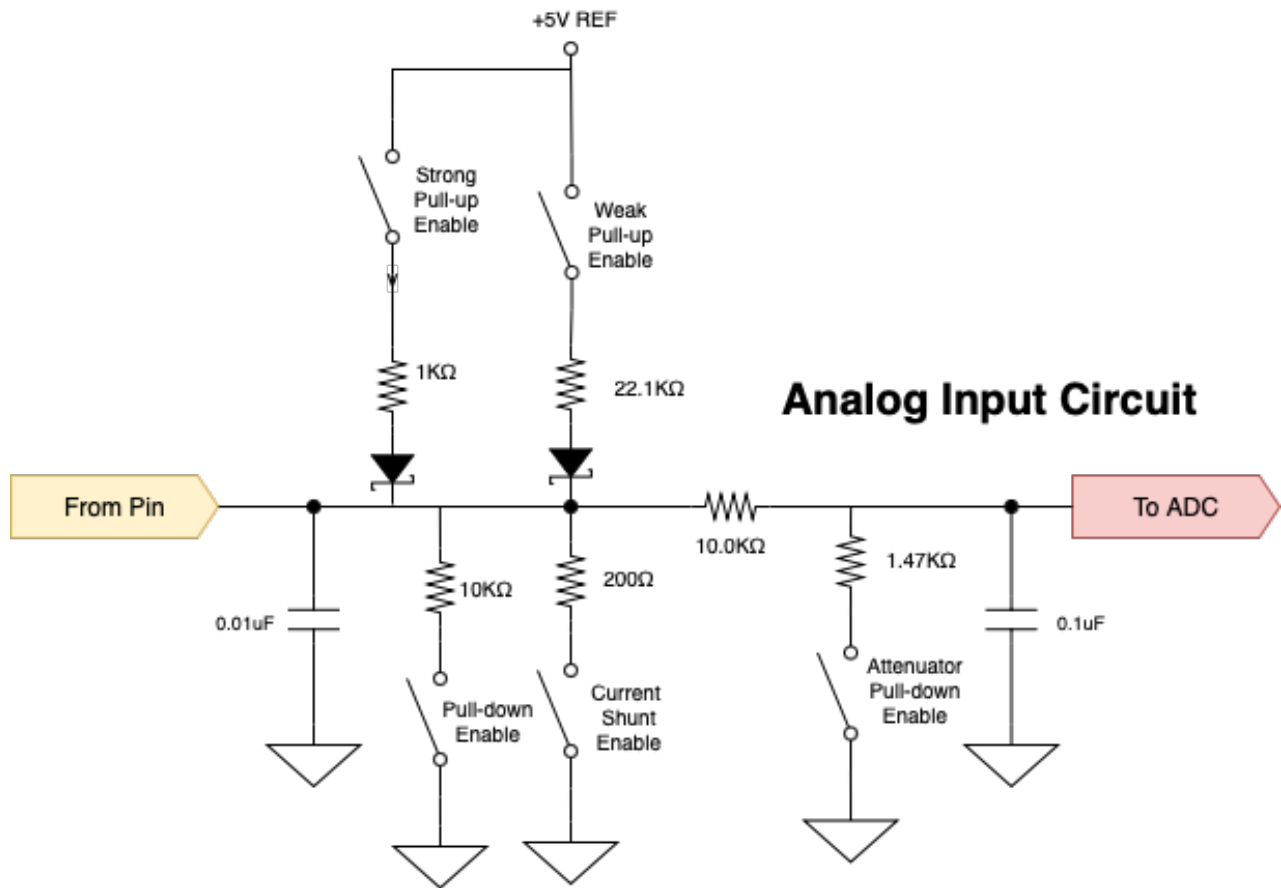

Below is a representation of the frequency input circuit and it depicts the various pull-ups and pull-downs that allow for various different operational modes required for interfacing different input devices.

Frequency Input Circuit (Passive Representation)

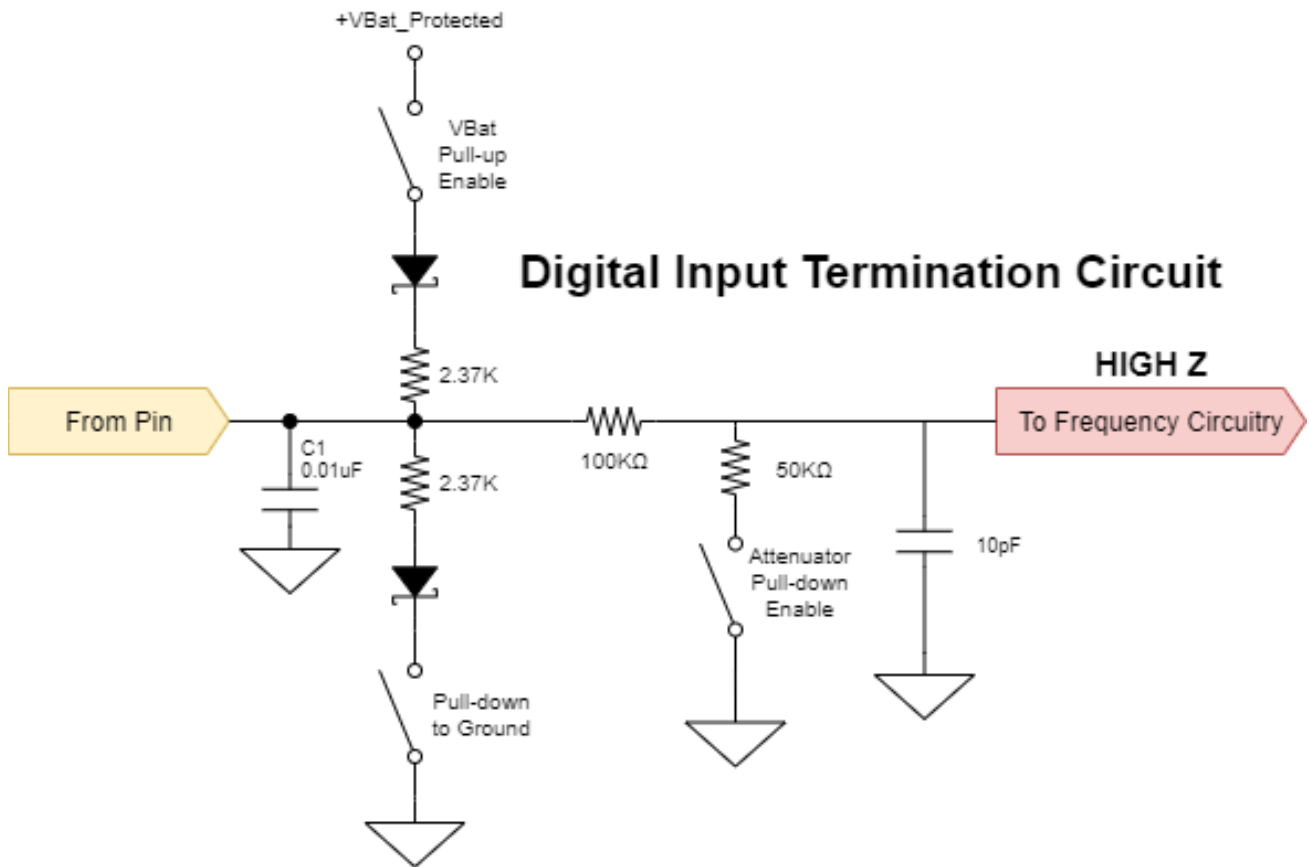

Appendix C – Deep Dive: PWM and Dither

What is PWM?

PWM stands for Pulse Width Modulation. It is a method that can be used to efficiently drive solenoid valves. Typically, the output device is switched at a fast rate (60 Hz – 2 kHz).

In the past, solenoid valves were driven using a transistor or op amp in linear mode. This worked well to control the valve as a directly proportional voltage signal could be easily controlled using feedback. The negatives of this technique are that it generates a great deal of heat, is inefficient, and requires a larger enclosure since the output device is operated in between cutoff and saturation and is behaving like a variable resistance, constantly having to dissipate the power not used by the load as heat.

PWM uses the output device digitally and therefore the device is either On or Off. Using this technique, the output device supplies a series of pulses of the same voltage level to the load. Since transistors are very efficient when either On or Off, much less heat is dissipated. By varying the duty cycle (on time/switching period) the output effectively can emulate an analog signal, especially at the higher switching frequencies through a solenoid valve coil's inductance.

Current feedback can be used to more effectively control the valve. With a known current flowing through the valve coil, the valve spool position can be precisely determined. The added advantage of this method is that it is independent of temperature.

What is Dither?

Dither is a small modulation of the PWM signal. This is intended to compensate for stiction and hysteresis by continually changing the PWM signal slightly and thus keeping the valve spool in constant motion. This can dramatically improve the valve performance by improving response to small signal changes.

The following oscilloscope images illustrate both the PWM voltage and current waveforms. Also illustrated are the effects of varying PWM duty cycle and of adding Dither.

PWM Waveforms

PWM Using No Dither

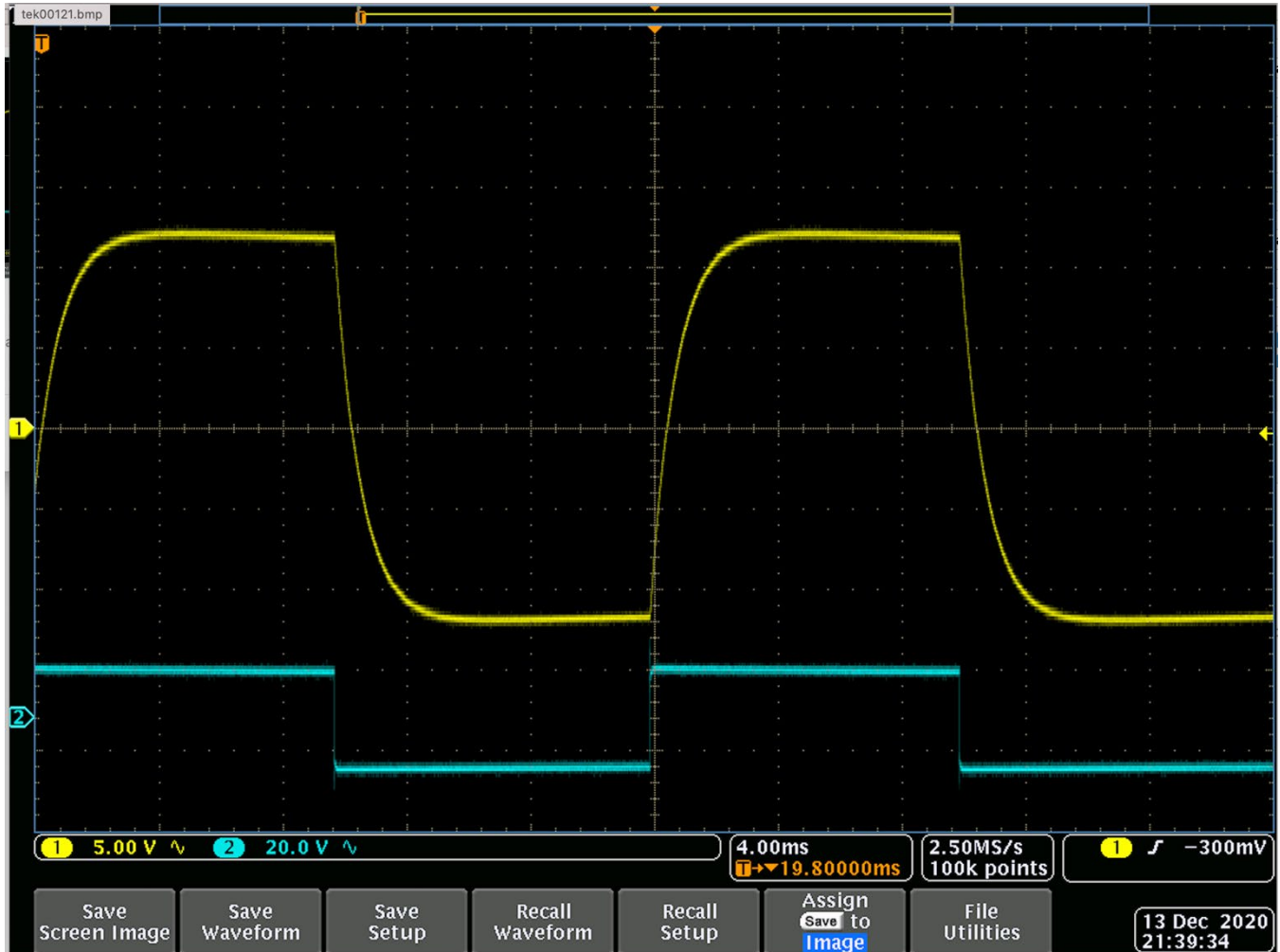

Depiction of 50 Hz PWM using no Dither. Lower waveform is voltage, upper waveform is the signal passed through a low pass filter (note no Dither present).

PWM Using Sinusoidal Dither

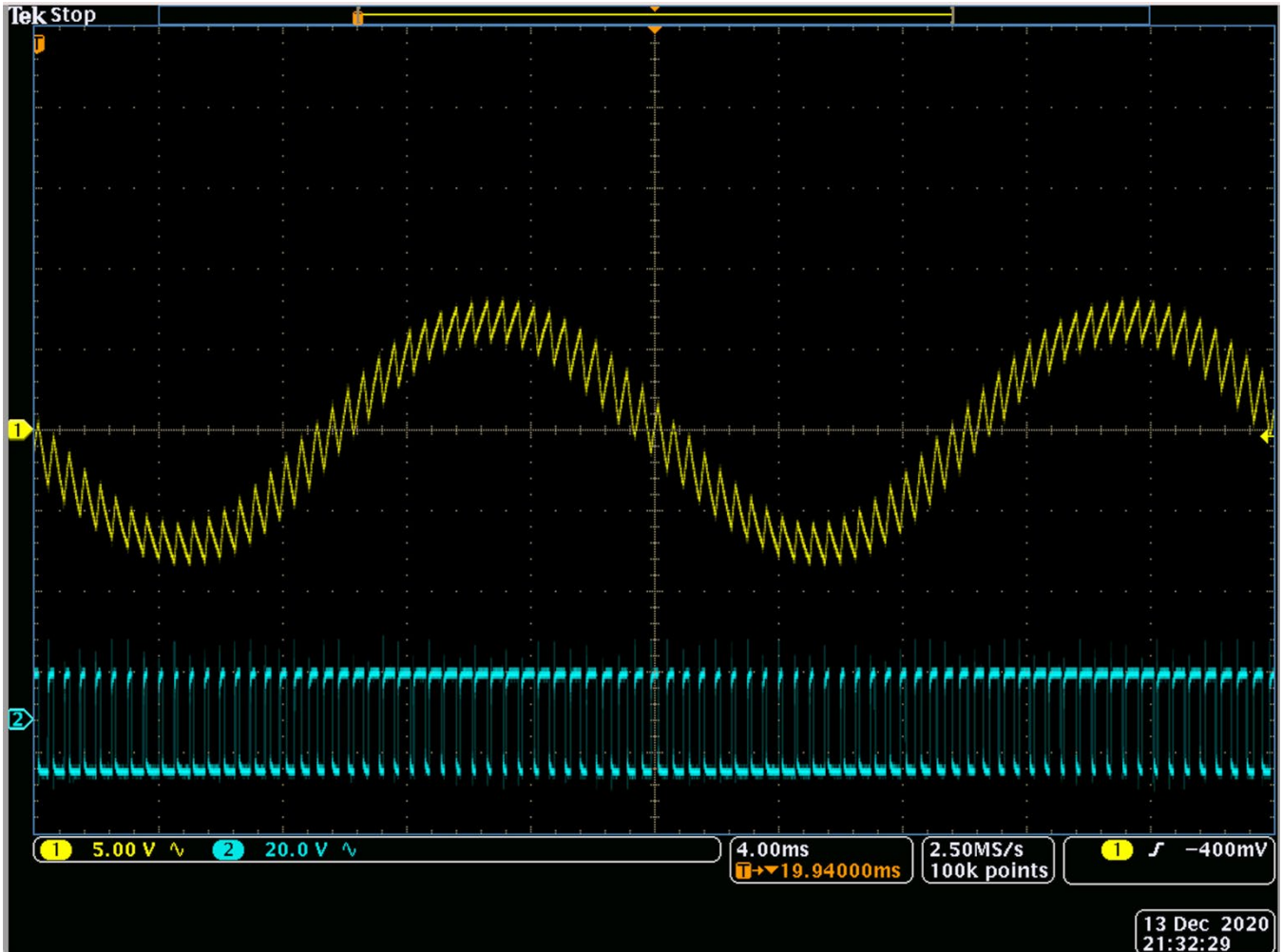

Depiction of 2 kHz PWM waveform using sinusoidal Dither (30% amplitude @ 50 Hz frequency). Lower waveform is voltage of base PWM, upper waveform is an extracted representation of the Dither signal captured using a low pass filter.

PWM Using Sinusoidal Dither (close-up)

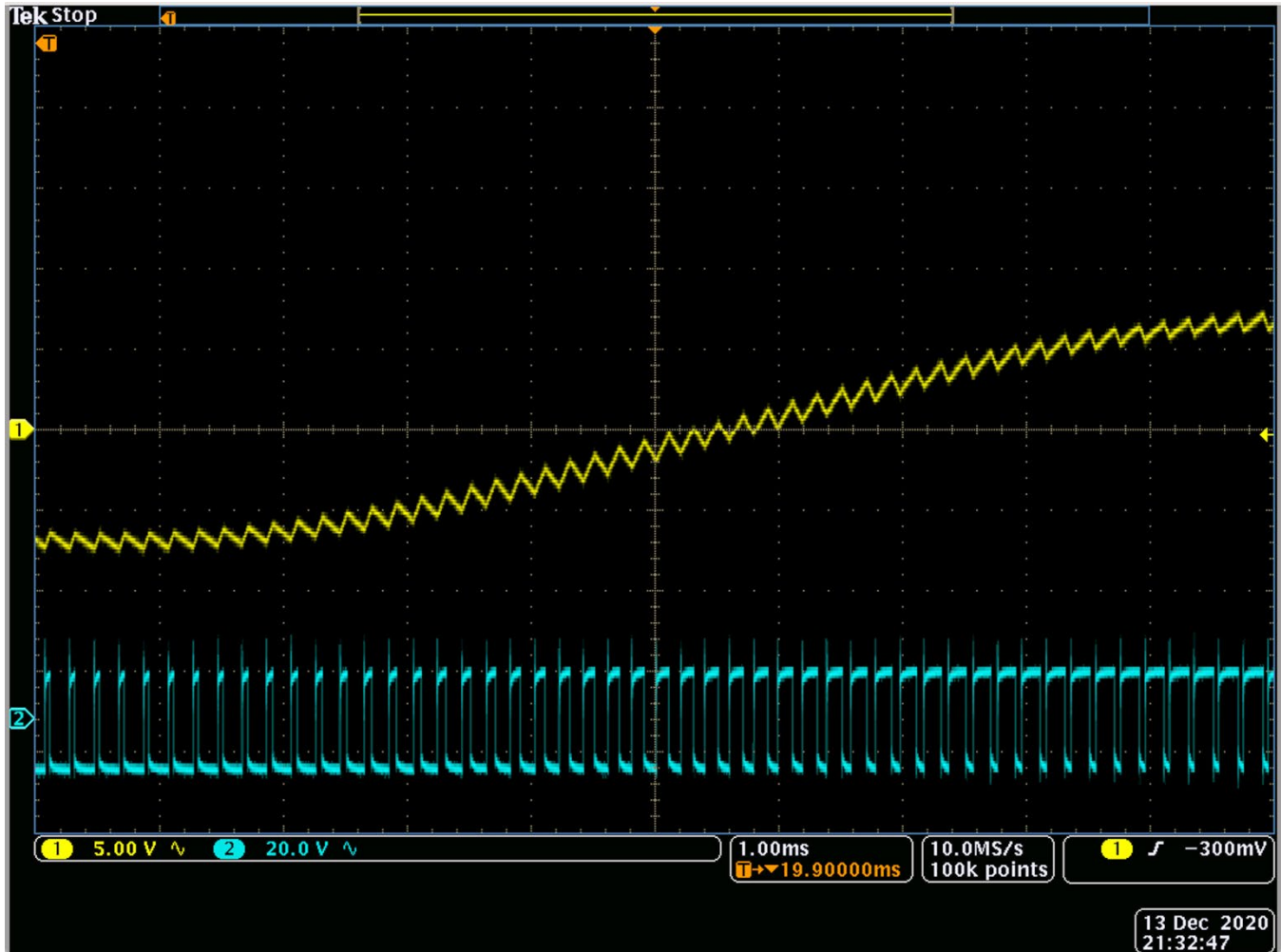

Depiction of 5 kHz PWM waveform using sinusoidal Dither (30% amplitude @ 250 Hz). Lower waveform is voltage of base PWM, upper waveform is an extracted representation of the Dither signal captured using a low pass filter. Note how this clearly depicts the Dither waveform modulating the PWM duty cycle of the base PWM waveform.

PWM Using Square Wave Dither

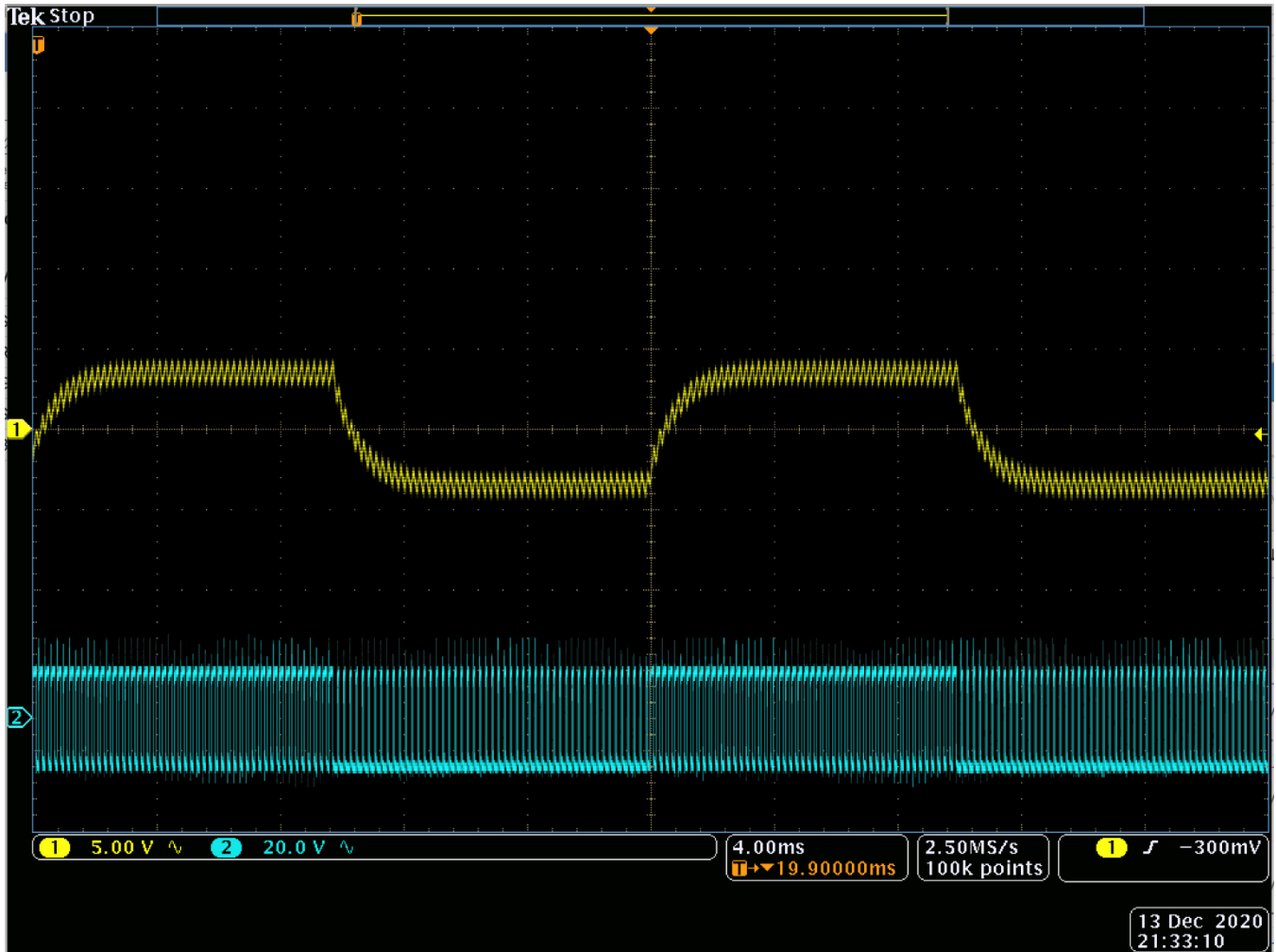

Depiction of 5 kHz PWM waveform using square wave Dither (30% amplitude @ 50 Hz). Lower waveform is voltage of base PWM, upper waveform is an extracted representation of the Dither signal captured using a low pass filter.

PWM Using Square Wave Dither (close-up)

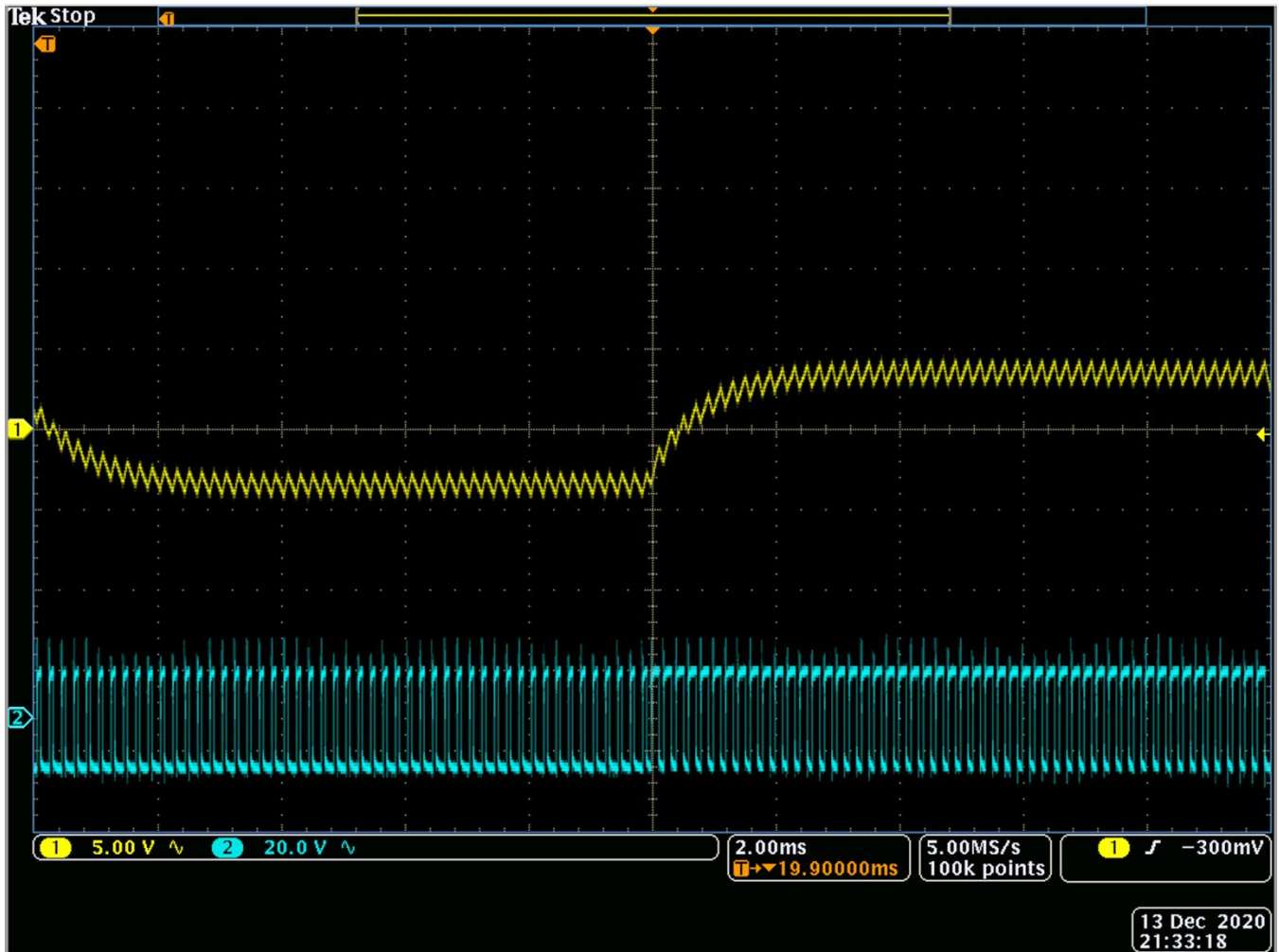

Depiction of 5 kHz PWM waveform using square wave Dither (30% amplitude @ 50 Hz). Lower waveform is voltage of base PWM, upper waveform is an extracted representation of the Dither signal captured using a low pass filter. Note how this clearly depicts the Dither waveform modulating the PWM duty cycle of the base PWM waveform.

Appendix D – Device Communication Troubleshooting

The following is a list of things to check, in order of priority, if you are having problems connecting to your controller from CODESYS.

1. Make sure the device is powered On. You should see a red light on LED A of the device. It is okay if this is flashing (this signifies the controller is currently in Run mode).
2. Make sure the serial port is connected and Windows has properly loaded the drivers. In the Device Manager under "Ports" you should see an entry that says, "Silicon Labs Dual CP210x USB to UART Bridge: Enhanced COM Port".
3. Make sure that the gateway.cfg file has been properly installed per the instructions in this document. Installation of a non-Enovation Controls device gateway may have overwritten this file.
4. In the CODESYS "Communication Settings", select "None" for the "Filter". Then re-scan for the device. If something new shows up, then it could be that the device variant being used by your project is different than the connected device. CODESYS will only let you connect to a device variant that matches the configuration of your project. To switch to the appropriate device, right click on it in the "Devices" project tree and select "Update Device".
5. Stop and start the gateway. Plug and unplug the USB port.
6. Restart CODESYS.
7. Restart your PC.
8. In some cases Windows will automatically assign a high COM port number to the USB device. If the device manager shows something higher than "COM20" then you should reassign it to something lower. Then restart the gateway and unplug and plug the USB port.
9. Each time a unique mobile controller is connected to your PC, Windows will provide 2 new COM port numbers. In some cases, CODESYS appears to have problems automatically discovering the device's COM port when the value gets too high. In this case there are 2 options:
 - From the device manager, click the COM port's properties, select "Port Settings" tab, click "Advanced", and select a "Com Port Number" that is below COM20. Then restart the gateway and re-plug the USB device to ensure changes are applied properly.
 - You can alternately edit the gateway.cfg to manually assign your device's COM port number. Open the gateway.cfg file located in the CODESYS install directory and change the line that begins with "Com.0.Port". After making this change, restart the gateway.

NOTE: After making this change, your installation will no longer automatically detect other controllers so this must be repeated for all unique controllers that are connected to your PC.

Appendix E – Hardware Specifications

The following specifications define the uControl specific variants of Enovation Controls' MC (Machine Control) Platform. The control modules detailed in this specification are intended to be used to control hydraulic systems, electric motors, lights, relays, and similar devices requiring power on mobile off-highway equipment.

1. Functional Specification

1.1 Physical & Environmental

Dimensions	Refer to 3.5 for all variants
Weight	To be determined
Storage Temperature Range	-40 °C to +125 °C
Operating Temperature Range	-40 °C to +105 °C (Limited to +85°C at full rated current)
IP Rating	IP67 (IP69K with harness-side rated boots)
Operating Altitude	0-4000 m

1.2 Power Supply

Supply Voltage Range	6-32 VDC, Nominal Operation @ 12 /24 VDC
Maximum Supply Voltage	36 VDC
Maximum Current	50 A (25 A with only 1 Power / 1 GND connected) Note: Applies to MC3-18-10 & MC4-24-20) 100A Applies to MC4-18-14-H8
Idle Current 12/24 VDC @ ambient temperature	< 200mA @ 12VDC < 200mA @ 24VDC
Standby (Sleep) Current 12/24 VDC @ ambient temperature	< 5mA @12VDC < 2.5mA @ 24VDC
Sleep Pin	Control sleep, wake

1.3 CPU

CPU Type	Renesas Super H 72546
Frequency	200 MHz
Bit Width	32 Bit
FPU	Integrated on chip

1.4 Memory

Data Memory (RAM retain) (additional to CPU)	32 Kbyte
Flash (ROM program & data combined)	3.75 Mbyte (program 1,000 cycles, data 50,000 cycles from -40°C to 125°C)
SRAM	256 Kbyte
EEPROM	128 Kbyte
MRAM	32 Kbyte

1.5 Standards & Testing (pending)

Electrical Tests	Test Procedure / Details
Temperature extreme test	Powerup & 24-hour operation @-40°C & 85°C
Supply voltage variation	Internal test suite (dropouts, dips, random bounce, engine cranking). Reverse voltage test is -32 V for 1 minute.
Short circuit protection	Power outputs and signal lines all inputs & powered outputs are shorted to Vbat & then ground for 1 minute each
Conducted immunity (power leads)	SAE J1113-2 reference MIL-STD-461F
Conducted immunity (BCI)	SAE J1113-4 reference ISO 11452-4
Conducted immunity (transients on power leads)	SAE J1113-11 reference ISO 7637-2 5 pulses of 174V for 350 ms with 4Ω source impedance. Severity level 4, response I.
Conducted immunity (coupling clamp on signal lines)	SAE J1113-12 reference ISO 7637-3
ESD immunity	SAE J1113-13 reference ISO 10605 EN 61000-4-2 - 8kV contact & 16 kV air Response level I.
Radiated immunity (absorption lined chamber)	SAE J1113-21 reference ISO 11452-2 >150 V/m (200MHz -3.2GHz)
Radiated immunity (magnetic fields)	SAE J1113-22 reference MIL-STD-461F
Radiated immunity (ac electric fields -power lines)	SAE J1113-26
Conducted emissions (power lines)	CISPR 25
Conducted emissions (signal lines)	CISPR 25
Radiated emissions	CISPR 25
ESD immunity	EN 60945 reference EN 61000-4-2
Radiated immunity	EN 61326-1 reference EN 61000-4-3
Conducted immunity (fast transients on power & signal lines)	EN 61326-1 reference EN 61000-4-4

Electrical Tests	Test Procedure / Details
Conducted immunity (surges on power lines)	EN 61326-1 reference EN 61000-4-5
Conducted immunity (RF disturbance)	EN60945 reference EN 61000-4-6
Magnetic immunity	EN 61326-1 reference EN 61000-4-8
Conducted emissions	EN 60945 reference CISPR 16-1
Radiated emissions	CISPR 11/EN60945 reference CISPR16-1
Broadband radiated emissions	2004/108/EC (E-Mark) reference CISPR 25 sec 6.4
Narrowband radiated emissions	2004/108/EC (E-Mark)
Radiated immunity	2004/108/EC (E-Mark) reference ISO11452-2
Conducted immunity	2004/108/EC (E-Mark) reference ISO 7637-2
Conducted emissions	2004/108/EC (E-Mark) reference ISO 7637-2
Inductive switching	SAE J1455 10 sequential 28V +/-600 V pulses of 1ms duration on I/O lines.

Mechanical Tests	Test Procedure / Details
HALT	Test Units Operational & Destruct Limits <ul style="list-style-type: none"> • Up to 100g RMS • Down to -100°C • Up to +200°C • Combined
HALT	Parameters will be defined based on results from HALT and application specific real-world temperature range & vibration usage profiles. Goal = Prove Reliability = B3 of 20,000+ Hours
IP6x	IEC 60529 Section 14.2.6 SAE J1455, Section 4.7.3
IPx7	IEC 60529 Section 14.2.7
IPx9K	IEC 60529, Section 14.2.9 (with protective boot)
Vibration	J1455 Section 4.10.4.1/5.82Grms, 8 hours per axis
Shock	J1455 Section 4.10.4/6+/-pulses, 50 G's, 6 ms
Fluid Compatibility	J1455 Section 4.4.3
Handling Drop Test	J1455 Section 4.11.3.1/ 1-meter drop on concrete on each of 6 box faces
Salt Fog	ASTM-B117/96 Hours at 35°C 5% NaCl

Electrical Tests	Test Procedure / Details
Humidity/Temperature cycling	SAE J1455 4.2.3 with reference to ISO 15998-7.2.2 for temperature & humidity levels

1.6 Certifications (pending)

1.6.1 CE Mark

The product is CE compliant. Please refer to the standards listed.

1.6.2 REACH / RoHS

This product is compliant with REACH / RoHS.

1.6.3 e-Mark

This product is e-Mark compliant.

1.7 CAN Communications

CAN Specification	2.0B
Channels	2 for MC2 platform, 3 for MC3 and MC4 platforms
Baud rates	Software configurable: 250 kb/s to 1Mb/s
Protocol	J1939
Performance	250 kb/s with three busses active. Busses loaded to 90% 90%, and 50% capacity. No messages lost in 5 minutes of operation at specified loading.

1.8 Sensor Supply

Number of Sensor Supplies	1 supply for MC2 and MC3 platform 2 supplies for MC4 platform
Sensor Supply Output Voltage	5 VDC or 10 VDC (Software Selectable)
Accuracy	+/- 1% relative to internal ADC reference
Sensor Supply Maximum Current @ ambient temperature	400mA @ 5 VDC output 400mA @ 10 VDC output
Protection	Overcurrent shutdown Overtemperature shutdown Short circuit Against application of external voltage

1.9 Inputs

Below are general functions of the inputs. Combinations of these functions make up multi-function inputs. Refer to Pinout for details.

1.9.1 Analog Function

ADC Resolution	12 bits
Accuracy (0-5 VDC mode)	Typical +/- 1 % FS
Accuracy (all other modes)	Typical +/- 1 % FS
Measuring Ranges	0...5V (Absolute & Ratiometric), 0...12V, 0...36V, 0...20mA

1.9.1.1 Voltage Mode - 0...5V

Supported Channels	(refer to Pinout)
Input Resistance	Nominally 10k Ω
Sampling Frequency	1kHz

1.9.1.2 Voltage Mode - 0...36V

Supported Channels	(refer to Pinout)
Input Resistance	Nominally 10k Ω
Sampling Frequency	1kHz

1.9.1.3 Current Mode - 0...22 mA

Supported Channels	(refer to Pinout)
Input Resistance	200 Ω
Sampling Frequency	1kHz

1.9.1.4 Resistive Mode - 100 Ω ...100 k Ω

Supported Channels	(refer to Pinout)
Input Resistance	Nominally 22k Ω (table 1), 1k Ω (table 2)
Sampling Frequency	1kHz

1.9.3 Digital Functions

1.9.3.1 Digital Mode

Supported Channels	(refer to Pinout)
Type	Low/High side (Software configurable)
Input Impedance	Nominally 10 k Ω
Sampling Frequency	250 Hz
Switch-on Level	Software Configurable from 0 to 36V
Switch-off Level	Software Configurable from 0 to 36V

1.9.3.2 High Frequency Mode

Supported Channels	(refer to Pinout)
Type	Single ended, digital low/high side software configurable
Input Impedance	Nominally 10 k Ω pull-up to 5V Nominally 2.2k Ω pull-up to system voltage
Input Frequency	Threshold 1: 1Hz...50kHz, Threshold 2: 1 Hz to 25kHz
Input Voltage Range	Selectable digital threshold with hysteresis
Threshold 1 for digital signals in the range of 0 – 5 V	Standard switch on at 2.5 V Standard switch off at 1.25 V
Threshold 2 for digital signals in the range of 0 – System supply V	Standard switch on at 7.5 V Standard switch off at 3.75 V

1.9.4 Sleep Function

Supported Channels	Sleep
Type	Analog Input w/ specialty function on power up
Purpose	Can be used for sleep and wake features.

1.10 Outputs

1.10.1 Digital Output - 4A

Type	Half-bridge output with software selectable operational modes (Not for proportional drive)
Operational Mode	Push - Pull, Low side, High side
Extended Mode	H-Bridge when paired with an output channel with the same rating
Max Current Rating	10 A
Continuous Current Rating	4 A
Diagnostics	Open/Short Circuit Protection, Current Feedback
Fault Modes	Auto-recovery or latching overcurrent Auto-recovery or latching short circuit or open circuit Overtemperature

1.10.2 Proportional PWM Output - 4A

Type	Half-bridge output with software selectable operational mode
Operational Mode	Push – Pull, Low side, High side
Extended Mode	Proportional drive via PWM Closed Loop Current Control H-Bridge when paired with an output channel with the same rating
Maximum Current Rating	10 A
Continuous Current Rating	4 A
Diagnostics	Open/Short Circuit Protection, Current Feedback
PWM Frequency	50 Hz – 5 kHz
Dither Frequency	Configurable
Dither Amplitude	Configurable
Control Range	0.05 - 4A
Control Resolution	1 mA
Fly Back Protection	Integrated
Duty Cycle Resolution	.01% @ 250Hz
Fault Modes	Auto-recovery or latching overcurrent. Auto-recovery or latching short circuit or open circuit. Overtemperature

1.10.3 Proportional PWM Output Dual Range - 4A / 0.4A

Type	Half-bridge output with software selectable operational mode
Operational Modes	Push – Pull, Low side, High side
Extended Modes	Proportional drive via PWM Closed Loop Current Control (Low & High Current Modes) H-Bridge when paired with an output channel with the same rating
Maximum Current Rating	10 A (note: Low Current Mode: 1A)
Continuous Current Rating	4 A (note: Low Current Mode: 0.4A)
Diagnostics	Open/Short Circuit Protection, Current Feedback
PWM Frequency	50 Hz – 5 kHz
Dither Frequency	Configurable
Dither Amplitude	Configurable
Control Range	Low Current Mode: 0.005 – 0.4A High Current Mode: 0.05 - 4A (software configurable)
Control Resolution	Low Current Mode: 1mA High Current Mode: 1 mA (software configurable)
Fly Back Protection	Integrated
Duty Cycle Resolution	.01% @ 250Hz
Fault Modes	Auto-recovery or latching overcurrent. Auto-recovery or latching short circuit or open circuit. Overtemperature

1.10.4 PWM Output – 15A Single, 25A in parallel mode

Type	Half-bridge output with software selectable operational mode
Operational Modes	Push – Pull, Low side, High side
Extended Modes	Proportional drive via PWM Closed Loop Current Control H-Bridge when paired with an output channel with the same rating Paralleled when paired with an output channel with the same rating (Note: Only digital non proportional)
Maximum Current Rating	40 A
Continuous Current Rating	15 A (Parallel with mated high side driver for 25A)
Diagnostics	Open/Short Circuit Protection, Current Feedback
PWM Frequency	50 Hz – 2 kHz
Dither Frequency	Configurable
Dither Amplitude	Configurable
Control Range	0.1A – 15A Up to 25A as a nonproportional high side output (when in parallel with additional high side channel)
Control Resolution	20mA
Fly Back Protection	Integrated
Duty Cycle Resolution	.01% @ 250Hz
Fault Modes	Auto-recovery or latching overcurrent. Auto-recovery or latching short circuit or open circuit. Overtemperature
Output Indication	Optional LED with output state & fault state Single Green LED per output

1.10.5 LED Indicators

1.10.5.1 Controller Level Status

Power Status	1x Green LED
Software Configurable	1x Amber LED
Software Configurable	1x Blue LED

1.10.5.2 High Current Output Status

Output Status	Color and Behavior
Output Inactive	Indicator is Dark
Output Active	Solid Green
Output in Fault	Output LED blinking @ 5Hz

Note: 8 LEDs, 1 for each high current output.

2. Physical Specification & Variants

The Generic version of the uControl controllers will consist of the following fully specified model variants.

2.1 uControl Variants

- MC2-18-6
- MC3-21-10
- MC4-26-20
- MC4-21-14-H8

2.2 Summary of I/O

Inputs	MC2-18-6	MC3-21-10	MC4-26-20	MC4-21-14-H8
Universal Analog / High Frequency	4	8	10	8
Universal Analog	14	13	16	13
TOTAL INPUTS	18	21	26	21

Outputs	MC2-18-6	MC3-21-10	MC4-26-20	MC4-21-14-H8
4A PWM (feedback)	2	6	10	6
Dual Range PWM 4A / 0.4 A (feedback)	4	4	10	8
15A PWM (feedback)	0	0	0	8
TOTAL OUTPUTS	6	10	20	22

Other	MC2-18-6	MC3-21-10	MC4-26-20	MC4-21-14-H8
CAN	2	3	3	3
Sensor Supply	1	1	2	2

2.3 Connections

2.3.1 Mating Connector J1A – 4 Pin

Manufacturer	Deutsch Inc.
Harness-side Connector Part Number	DTP06-4S
Harness-side Terminal Part Number	1062-12-0166 Stamped & Formed, Nickel-plated
Harness-side Wedge Part Number	WP-4S
Harness-side Accessories	Enovation P/N 58000017 (10' harness w/ J1B)

2.3.2 Mating Connector J1B – 6 Pin

Manufacturer	Deutsch Inc.
Harness-side Connector Part Number	DT06-6S-E008
Harness-side Terminal Part Number	1062-16-0122 Stamped & Formed, Nickel-plated
Harness-side Wedge Part Number	W6S
Harness-side Accessories	Enovation P/N 58000017 (10' harness w/ J1A)

2.3.3 Mating Connector J1 – 18 Pin with E Key

Manufacturer	Deutsch Inc.
Harness-side Connector Part Number	DT16-18SE-K004
Harness-side Terminal Part Number	1062-16-0122 Stamped & Formed, Nickel-plated
Harness-side Accessories	Enovation P/N 58000016 (10' harness)

2.3.4 Mating Connector J2 – 18 Pin with A Key

Manufacturer	Deutsch Inc.
Harness-side Connector Part Number	DT16-18SA-K004
Harness-side Terminal Part Number	1062-16-0122 Stamped & Formed, Nickel-plated
Harness-side Accessories	Enovation P/N 58000012 (10' harness)

2.3.5 Mating Connector J3 – 18 Pin with B Key

Manufacturer	Deutsch Inc.
Harness-side Connector Part Number	DT16-18SB-K004
Harness-side Terminal Part Number	1062-16-0122 Stamped & Formed, Nickel-plated
Harness-side Accessories	Enovation P/N 58000013 (10' harness)

2.3.6 Mating Connector J4 – 18 Pin with C Key

Manufacturer	Deutsch Inc.
Harness-side Connector Part Number	DT16-18SC-K004
Harness-side Terminal Part Number	1062-16-0122 Stamped & Formed, Nickel-plated
Harness-side Accessories	Enovation P/N 58000014 (10' harness)

2.3.7 Mating Connector J4 – 18 Pin with D Key

Manufacturer	Deutsch Inc.
Harness-side Connector Part Number	DT16-18SD-K004
Harness-side Terminal Part Number	1062-16-0122 Stamped & Formed, Nickel-plated
Harness-side Accessories	Enovation P/N 58000015 (10' harness)

2.4 Pinouts

2.4.1 MC2-18-6 Pinout view with functions

(Note: 2 – 18 Pin Connectors)

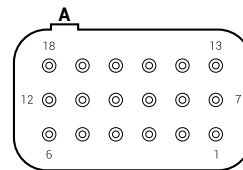
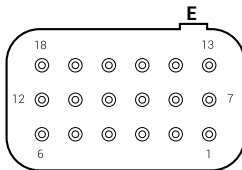
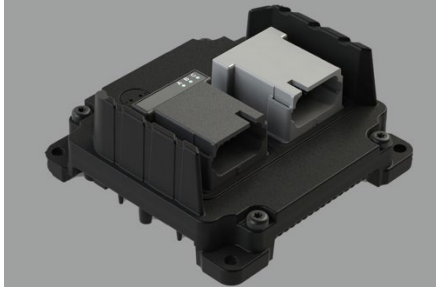

Connector J1 Key E	
Pin	Function
E1	Power Battery (+)
E2	Output PWM 4A With Feedback
E3	Output PWM 4A With Feedback
E4	Input Universal Analog
E5	Load Power (+)
E6	Battery Ground (-)
E7	Sleep Mode
E8	Output PWM Dual Range 4A / 0.5A
E9	Output PWM Dual Range 4A / 0.5A
E10	Input Universal Analog
E11	Load Power (+)
E12	Battery Ground (-)
E13	Output PWM Dual Range 4A / 0.5A
E14	Output PWM Dual Range 4A / 0.5A
E15	Input Universal Analog
E16	Input Universal Analog
E17	Input Universal Analog
E18	Input Universal Analog

Connector J2 Key A	
Pin	Function
A1	Sensor Supply Output (+10V/+5V)
A2	CAN2 H / RS232 TX
A3	CAN1 H
A4	Input Universal Analog
A5	Input Universal Analog
A6	Input Universal Analog
A7	Input Universal Analog / High Freq.
A8	CAN2 L / RS232 RX
A9	CAN1 L
A10	Input Universal Analog / High Freq.
A11	Input Universal Analog / High Freq.
A12	Input Universal Analog / High Freq.
A13	Sensor Supply Ground (-) / RS232 GND
A14	Input Universal Analog
A15	Input Universal Analog
A16	Input Universal Analog
A17	Input Universal Analog
A18	Input Universal Analog

2.4.2 MC3-21-10 Pinout view with functions

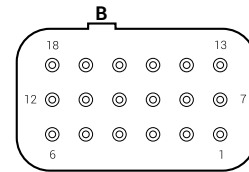
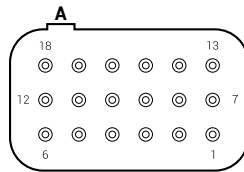
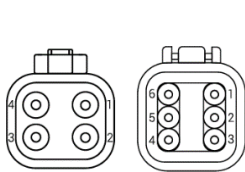
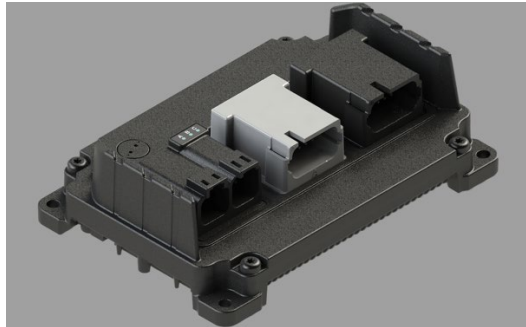

Connector J1 A,B	
Pin	Function
PA1	Load Power (+)
PA2	Battery Ground (-)
PA3	Load Power (+)
PA4	Battery Ground (-)
PB1	Battery Positive (+)
PB2	CAN1 H
PB3	Input Universal Analog
PB4	Battery Ground (-)
PB5	CAN1 L
PB6	Sleep Mode

Connector J2 Key A	
Pin	Function
A1	Sensor Supply Output (+10V/+5V)
A2	CAN2 H / RS232 TX
A3	CAN3 H
A4	Input Universal Analog
A5	Input Universal Analog
A6	Input Universal Analog
A7	Input Universal Analog / High Freq.
A8	CAN2 L / RS232 RX
A9	CAN3 L
A10	Input Universal Analog / High Freq.
A11	Input Universal Analog / High Freq.
A12	Input Universal Analog / High Freq.
A13	Sensor Supply Ground (-)/ RS232 GND
A14	Input Universal Analog
A15	Input Universal Analog
A16	Input Universal Analog
A17	Input Universal Analog
A18	Input Universal Analog

Connector J3 Key B	
Pin	Function
B1	Input Universal Analog
B2	Output PWM 4A With Feedback
B3	Output PWM 4A With Feedback
B4	Output PWM 4A With Feedback
B5	Output PWM Dual Range 4A / 0.5A
B6	Output PWM Dual Range 4A / 0.5A
B7	Input Universal Analog / High Freq.
B8	Input Universal Analog / High Freq.
B9	Input Universal Analog / High Freq.
B10	Input Universal Analog / High Freq.
B11	Input Universal Analog
B12	Input Universal Analog
B13	Input Universal Analog
B14	Output PWM 4A With Feedback
B15	Output PWM 4A With Feedback
B16	Output PWM 4A With Feedback
B17	Output PWM Dual Range 4A / 0.5A
B18	Output PWM Dual Range 4A / 0.5A

2.4.3 MC4-26-20 Pinout view with function

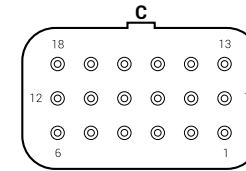
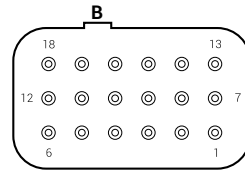
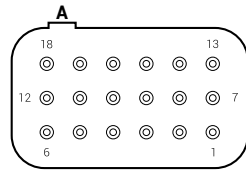
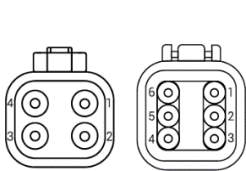
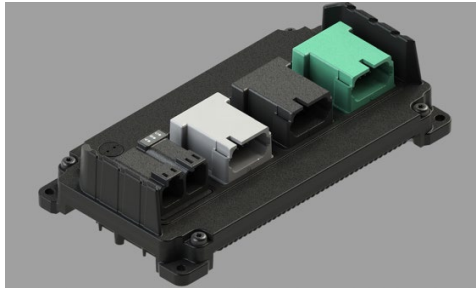

Connector J1 A,B	
Pin	Function
PA1	Load Power (+)
PA2	Battery Ground (-)
PA3	Load Power (+)
PA4	Battery Ground (-)
PB1	Battery Positive (+)
PB2	CAN1 H
PB3	No Connection
PB4	Battery Ground (-)
PB5	CAN1 L
PB6	Sleep Mode

Connector J2 Key A	
Pin	Function
A1	Sensor Supply Output (+10V/+5V)
A2	CAN2 H / RS232 TX
A3	CAN3 H
A4	Input Universal Analog
A5	Input Universal Analog
A6	Input Universal Analog
A7	Input Universal Analog / High Freq.
A8	CAN2 L / RS232 RX
A9	CAN3 L
A10	Input Universal Analog / High Freq.
A11	Input Universal Analog / High Freq.
A12	Input Universal Analog / High Freq.
A13	Sensor Supply Ground (-)/ RS232 GND
A14	Input Universal Analog
A15	Input Universal Analog
A16	Input Universal Analog
A17	Input Universal Analog
A18	Input Universal Analog

Connector J3 Key B	
Pin	Function
B1	Input Universal Analog
B2	Output PWM 4A With Feedback
B3	Output PWM 4A With Feedback
B4	Output PWM 4A With Feedback
B5	Output PWM Dual Range 4A / 0.5A
B6	Output PWM Dual Range 4A / 0.5A
B7	Input Universal Analog / High Freq.
B8	Input Universal Analog / High Freq.
B9	Input Universal Analog / High Freq.
B10	Input Universal Analog / High Freq.
B11	Input Universal Analog
B12	Input Universal Analog
B13	Input Universal Analog
B14	Output PWM 4A With Feedback
B15	Output PWM 4A With Feedback
B16	Output PWM 4A With Feedback
B17	Output PWM Dual Range 4A / 0.5A
B18	Output PWM Dual Range 4A / 0.5A

Connector J4 Key C	
Pin	Function
C1	Sensor Supply Output (+10V/+5V)
C2	Output PWM Dual Range 4A / 0.5A
C3	Output PWM Dual Range 4A / 0.5A
C4	Output PWM 4A With Feedback
C5	Output PWM Dual Range 4A / 0.5A
C6	Output PWM 4A With Feedback
C7	Input Universal Analog
C8	Input Universal Analog
C9	Input Universal Analog
C10	Input Universal Analog
C11	Input Universal Analog
C12	Input Universal Analog
C13	Sensor Supply Ground (-)
C14	Output PWM Dual Range 4A / 0.5A
C15	Output PWM Dual Range 4A / 0.5A
C16	Output PWM 4A With Feedback
C17	Output PWM Dual Range 4A / 0.5A
C18	Output PWM 4A With Feedback

2.4.4 MC4-21-14-H8 Pinout view with functions

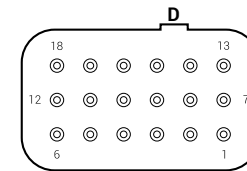
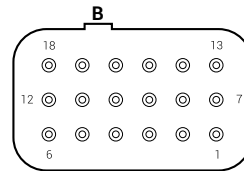
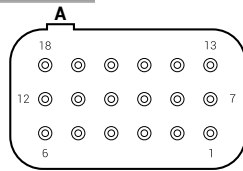
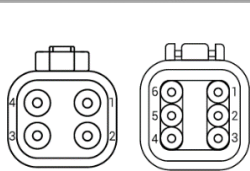
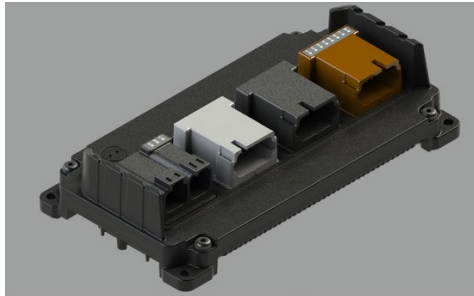

Connector J1 A,B	
Pin	Function
PA1	Load Power (+)
PA2	Battery Ground (-)
PA3	Load Power (+)
PA4	Battery Ground (-)
PB1	Battery Positive (+)
PB2	CAN1 H
PB3	Input Universal Analog
PB4	Battery Ground (-)
PB5	CAN1 L
PB6	Sleep Mode

Connector J2 Key A	
Pin	Function
A1	Sensor Supply Output (+10V/+5V)
A2	CAN2 H / RS232 TX
A3	CAN3 H
A4	Input Universal Analog
A5	Input Universal Analog
A6	Input Universal Analog
A7	Input Universal Analog / High Freq.
A8	CAN2 L / RS232 RX
A9	CAN3 L
A10	Input Universal Analog / High Freq.
A11	Input Universal Analog / High Freq.
A12	Input Universal Analog / High Freq.
A13	Sensor Supply Ground (-)/ RS232 GND
A14	Input Universal Analog
A15	Input Universal Analog
A16	Input Universal Analog
A17	Input Universal Analog
A18	Input Universal Analog

Connector J3 Key B	
Pin	Function
B1	Input Universal Analog
B2	Output PWM 4A With Feedback
B3	Output PWM 4A With Feedback
B4	Output PWM 4A With Feedback
B5	Output PWM Dual Range 4A / 0.5A
B6	Output PWM Dual Range 4A / 0.5A
B7	Input Universal Analog / High Freq.
B8	Input Universal Analog / High Freq.
B9	Input Universal Analog / High Freq.
B10	Input Universal Analog / High Freq.
B11	Input Universal Analog
B12	Input Universal Analog
B13	Input Universal Analog
B14	Output PWM 4A With Feedback
B15	Output PWM 4A With Feedback
B16	Output PWM 4A With Feedback
B17	Output PWM Dual Range 4A / 0.5A
B18	Output PWM Dual Range 4A / 0.5A

Connector J4 Key D	
Pin	Function
D1	Sensor Supply Output (+10V/+5V)
D2	Output PWM 15A With Feedback
D3	Output PWM Dual Range 4A / 0.5A
D4	Output PWM 15A With Feedback
D5	Output PWM Dual Range 4A / 0.5A
D6	Output PWM 15A With Feedback
D7	Load Power (+)
D8	Load Power (+)
D9	Output PWM 15A With Feedback
D10	Load Power (+)
D11	Output PWM 15A With Feedback
D12	Load Power (+)
D13	Sensor Supply Ground (-)
D14	Output PWM 15A With Feedback
D15	Output PWM Dual Range 4A / 0.5A
D16	Output PWM 15A With Feedback
D17	Output PWM Dual Range 4A / 0.5A
D18	Output PWM 15A With Feedback

2.5 Mounting Diagrams

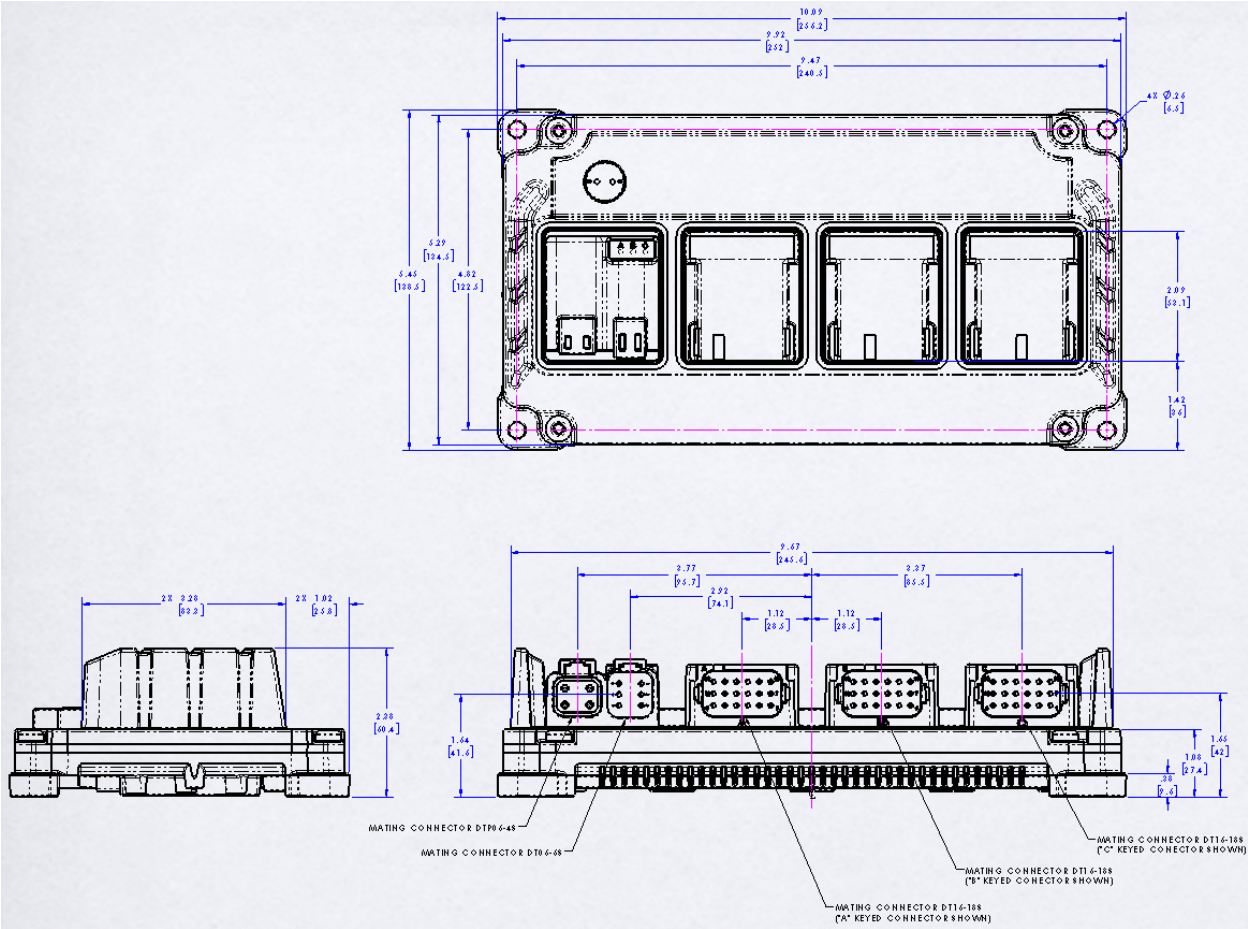

Figure 2.1: MC4 Envelope Dimensions

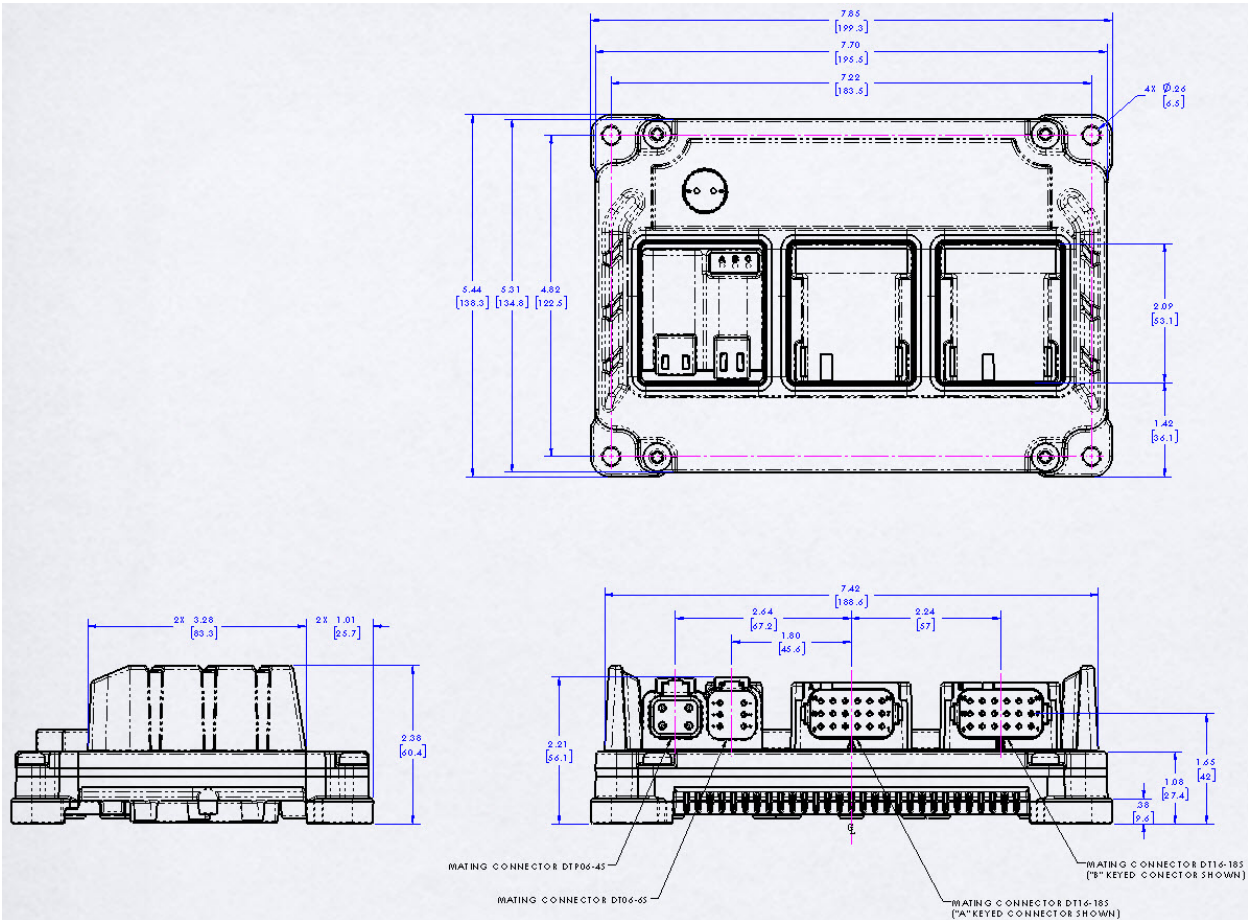

Figure 2.2: MC3 Envelope Dimensions

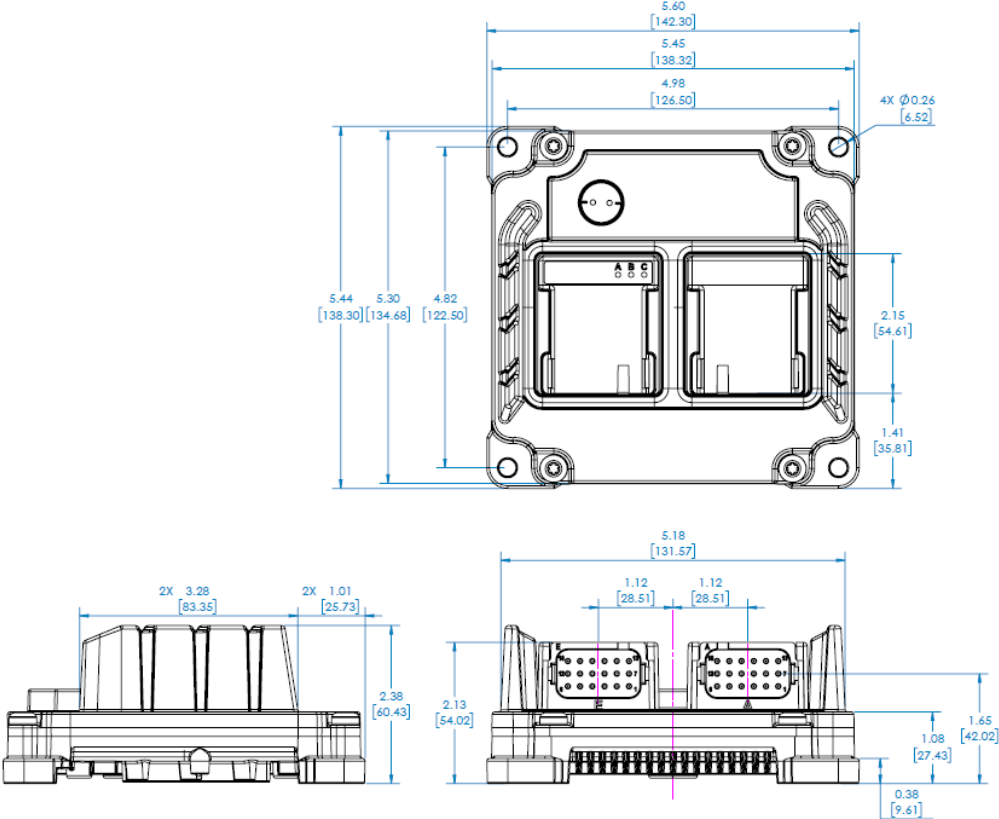

Figure 2.3 MC2 Envelope Dimensions

In order to consistently bring you the highest quality, full-featured products, we reserve the right to change our specifications and designs at any time. MURPHY products and the Murphy logo are registered and/or common law trademarks of Enovation Controls, LLC. This document, including textual matter and illustrations, is copyright protected by Enovation Controls, LLC, with all rights reserved. (c) 2021 Enovation Controls, LLC. A copy of the warranty may be viewed or printed by going to www.enovationcontrols.com/warranty

ENOVATION CONTROLS CORPORATE HEADQUARTERS
5311 S 122ND EAST AVENUE
TULSA, OK 74146

ENOVATION CONTROLS LTD. – UNITED KINGDOM
CHURCH ROAD LAVERSTOCK
SALISBURY SP1 1QZ UK

SUN MURPHY INTERNATIONAL TRADING (SHANGHAI) CO., LTD
B15 ROOM, 6# BUILDING, 351 SIZHUAN ROAD
SONGJIANG DISTRICT, SHANGHAI 201601, CHINA

ENOVATION CONTROLS INDIA PVT. LTD.
301, 3RD FLOOR, KRSNA CHAMBERS,
11 GALAXY GARDENS, NORTH MAIN ROAD,
KOREGAON PARK, PUNE 411001,
MAHARASHTRA, INDIA

U.S. SALES & SUPPORT

PHONE: 918 317 4100
EMAIL: SALES@ENOVATIONCONTROLS.COM
WWW.ENOVATIONCONTROLS.COM

INTERNATIONAL SALES & SUPPORT

EUROPE, MIDDLE EAST, AFRICA
PHONE: +44 1722 410055
EMAIL: SALES@ENOVATIONCONTROLS.EU

CHINA
PHONE: +86 21 6237 5885
EMAIL: APSALES@ENOVATIONCONTROLS.COM

INDIA
PHONE: +91 91581 37633
EMAIL: INDIASALES@ENOVATIONCONTROLS.COM



FM 28221 (Tulsa, OK - USA)
FM 29422 (UK)