



High Country Tek, Inc.

Dual Channel Valve Controller: **evc-2**

Electronic Control Solutions for the Global Fluid Power Industry



Application Information:

- **Dual Channel Open Loop Valve Controller**
- 12VDC or 24VDC system usage
- **Single valve or Dual coil directional proportional systems**
- Direct connection to joystick or potentiometer

Product Feature Overview:

- **Compatible with all major hydraulic manufacturers products**
- FREE– PC based set-up program included
- Control 2 separate proportional valves with one controller
- Solid flame resistant 'Potted' product - very physically robust
- Connector options to suit environment of application
- Diagnostic LED indicators
- Can be factory pre-set for serial production needs



Electrical Connection Diagram:

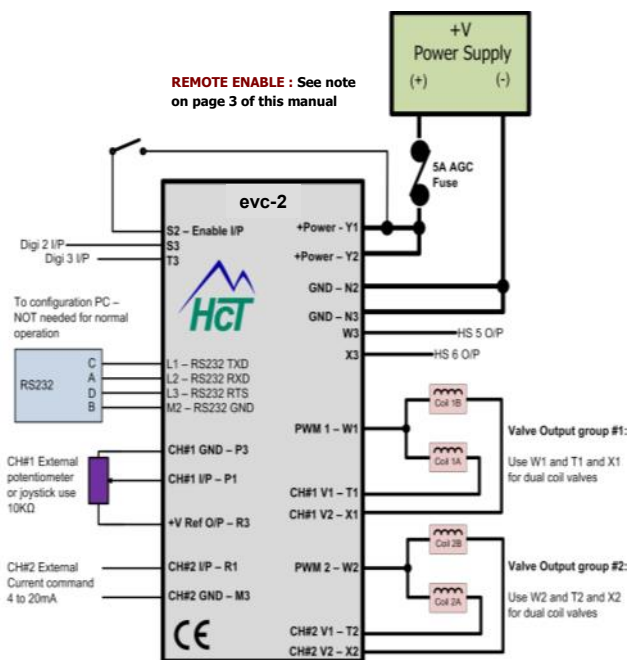

Configuration shown using 1x potentiometers or joysticks with internal regulated +5V and 1x externally provided 4-20mA command input to control 2x valve coil per channel.

Controller Specification Overview:

1. Module size/format: High Country Tek Inc. format
2. Design Standards: Full CE classification
3. Power Supply: 10 to 32VDC (max)
4. Module protection: 5A AGC fuse in power supply line
5. Reference voltage: + 5VDC \pm 10% @ 500mA (max)
6. Analog Inputs: 2x Inputs / DC V or Current loop (mA)
7. Analog I/P values: 0 to +5v or 0 to 20mA
8. Enable / Disable I/P: 1x ON/OFF
9. Digital input number: 2x ON/OFF
10. Digital input values: 0V to +V Power supply max
11. Digital output number: 2x High Side / ON/OFF
12. Digital output values: 0 to module supply voltage -0.5VDC
13. Digital output range: 0 to 3 amp max
14. Proportional O/P: 2x PWM
15. O/P Protection: Open and short circuit protection
16. O/p range: 0 to 3 amp max
17. Operating Temp.: -40C to +85C
18. Storage Temp.: -40C to +100C
19. IP / NEMA rating: IP67 / 69K / NEMA 6P
20. Connector type: Cinch. Metri-Pack 150 series

Controller Connection Details:

Dimensional Data:

evc-2 Connector Designation Tables					
30 Pin Metri-Pak Connector (Male, Plug)					
PIN	Name	PIN	Name	PIN	Name
L1	TXD			T3	DIG-3
L2	RXD	P3	PWR COM	W1	PWM-1
L3	RTS	R1	UNI-2	W2	PWM-2
				W3	HS-5
M2	PWR COM	R3	+5V USER	X1	HS-2
M3	PWR COM			X2	HS-4
		S2	DIG-1	X3	HS-6
N2	PWR COM	S3	DIG-2	Y1	+PWR IN-1
N3	PWR COM	T1	HS-1	Y2	+PWR IN-2
P1	UNI-1	T2	HS-3	Y3	+PWR IN-3

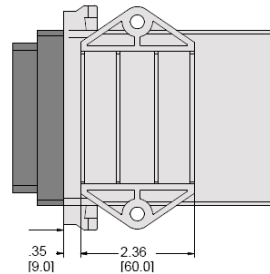
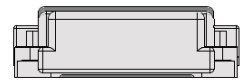
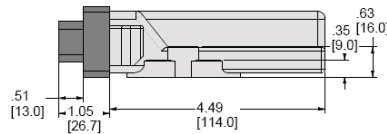
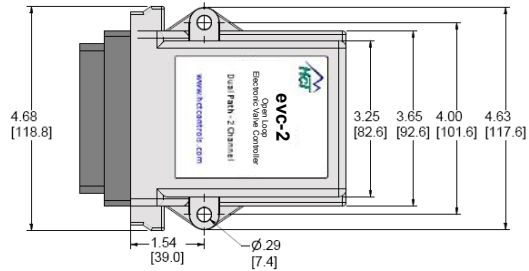

IMPORTANT NOTE:

Recommended tightening torques for the securing bolts are as follows:

For a 1/4-20 bolt, SAE Grade 5

DRY Torque: 8 Ft-Lbs
Lubricated Torque: 6.3 Ft-Lbs

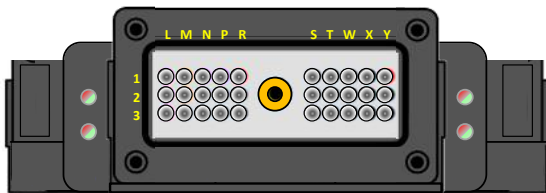

View looking at module male 30 way connector

evc-2 accessories - PC set-up cables:

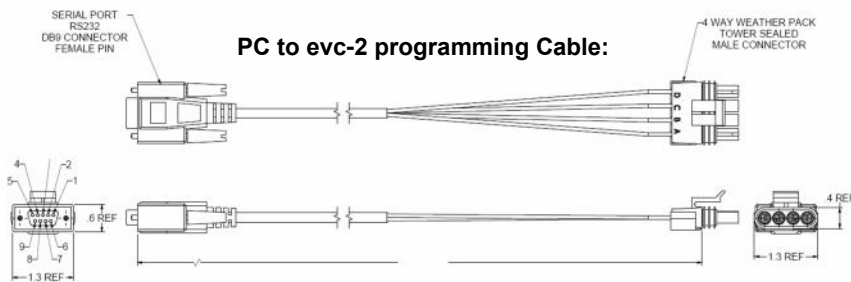

HCT Part Number:
999-10075

Need More Information ?

For the latest company and product information, visit us at:

www.hctcontrols.com

For customer service, pricing, order placement and application support, contact us through e-Mail at: info@hctcontrols.com



High Country Tek, Inc.

208 Gold Flat Court
Nevada City, CA, 95959
Tel: (1) 530 265 3236
Fax: (1) 530 265 3275

